

Typical Performance Curves

1.0 TYPICAL PERFORMANCE CURVES

Note: The following performance graphs are for the devices that are documented in the MCP41HVX1 data sheet (DS20005207). This document allows the MCP41HVX1 data sheet's functional description to be in PDF format with a file size smaller than the 10 MB limit of many email file servers.

The graphs and tables provided following this note are a statistical summary based on a limited number of samples and are provided for informational purposes only. The performance characteristics listed herein are not tested or guaranteed. In some graphs or tables, the data presented may be outside the specified operating range (e.g., outside specified power supply range) and therefore outside the warranted range.

Note: Unless otherwise indicated, $T_A = +25^\circ\text{C}$, $V_L = 5.5\text{V}$, $\text{DGND} = V^-$, $V^+ = 36\text{V}$.

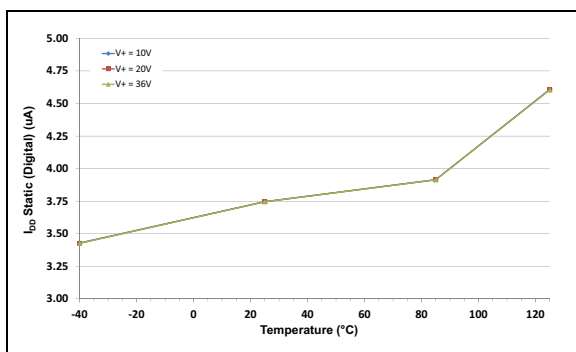

FIGURE 1-1: Device Digital Supply Static Current (I_{DD}) vs. Temperature and V^+ Voltage ($V_L = 5.5\text{V}$, $A = V^+$, $B = V^-$, $\text{DGND} = V^-$, $V^+ = 10\text{V}$, 20V , and 36V).

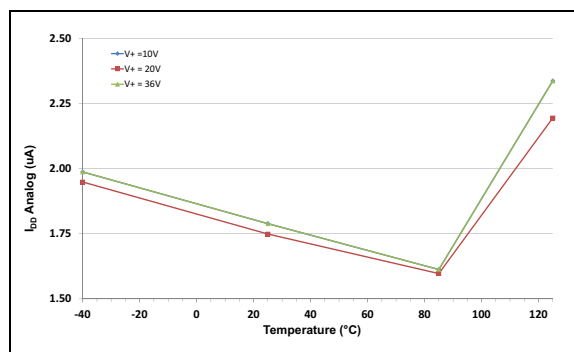

FIGURE 1-3: Device Analog Supply Static Current (I_{DDA}) vs. Temperature and V^+ Voltage ($V_L = 5.5\text{V}$, $A = B = V^-$, $\text{DGND} = V^-$, $V^+ = 10\text{V}$, 20V , and 36V).

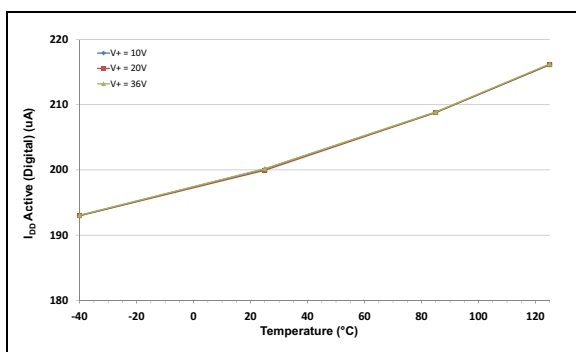

FIGURE 1-2: Device Digital Supply Active Current (I_{DD}) vs. Temperature and V^+ Voltage ($V_L = 5.5\text{V}$, $F_{\text{SCK}} = 5\text{MHz}$, $A = V^+$, $B = V^-$, $\text{DGND} = V^-$, $V^+ = 10\text{V}$, 20V , and 36V).

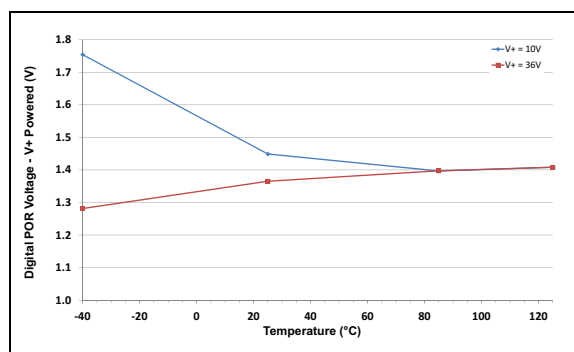

FIGURE 1-4: Digital Supply POR Voltage (V_{DPOR}) vs. Temperature and V^+ Voltage ($V^+ = 10\text{V}$ and 36V).

MCP41HVX1

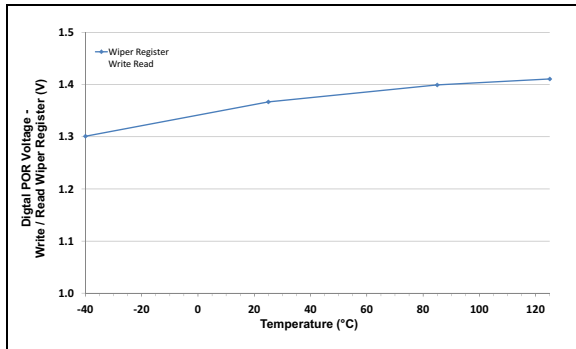

FIGURE 1-5: Digital Supply POR Voltage (V_{DPOR}) vs. Temperature (Analog Supply ($V+$ / $V-$) Not Powered).

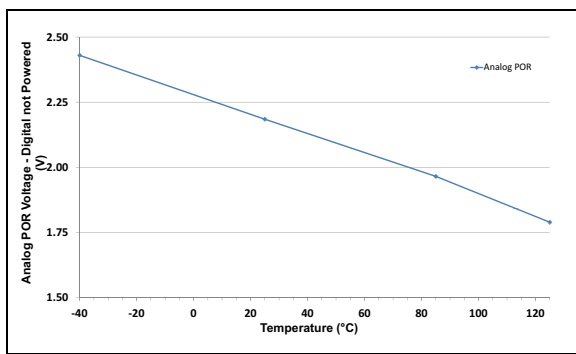

FIGURE 1-6: Analog Supply POR Voltage (V_{APOR}) vs. Temperature (Digital Supply (V_L / DGND) Not Powered).

Note: Unless otherwise indicated, $T_A = +25^\circ\text{C}$, $V_L = 5.0\text{V}$, $\text{DGND} = V^-$, $V^+ = 36\text{V}$.

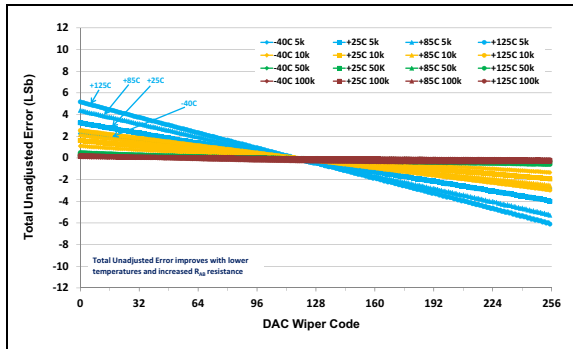

FIGURE 1-7: Total Unadjusted Error (Pot. Mode) (V_W) vs. Wiper Setting, R_{AB} Resistance, and Temperature (8-bit: $V_L = 1.8\text{V}, 2.7\text{V}, 5.5\text{V}$, $A = V^+$, $B = V^-$, $\text{DGND} = V^-$, $V^+ = 36\text{V}$).

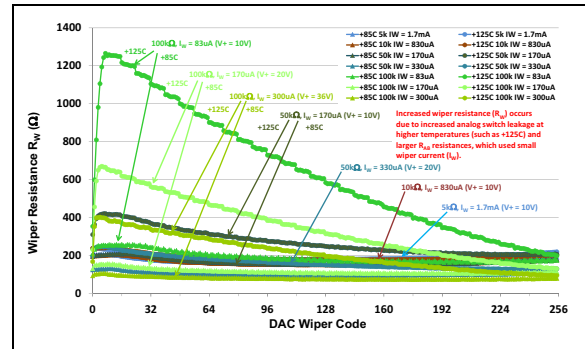

FIGURE 1-10: Wiper Resistance (R_W) vs. Wiper Setting, R_{AB} Resistance, I_W Current, and Temperature (8-bit: $V_L = 1.8\text{V}, 2.7\text{V}, 5.5\text{V}$, $A = V^+$, $B = V^-$, $\text{DGND} = V^-$).

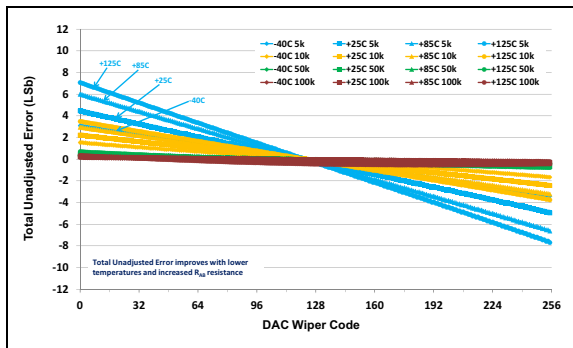

FIGURE 1-8: Total Unadjusted Error (Pot. Mode) (V_W) vs. Wiper Setting, R_{AB} Resistance, and Temperature (8-bit: $V_L = 1.8\text{V}, 2.7\text{V}, 5.5\text{V}$, $A = V^+$, $B = V^-$, $\text{DGND} = V^-$, $V^+ = 20\text{V}$).

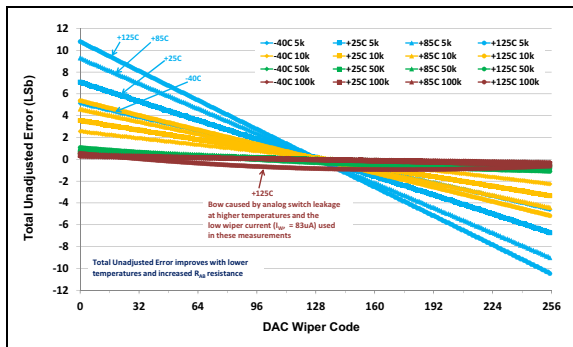

FIGURE 1-9: Total Unadjusted Error (Pot. Mode) (V_W) vs. Wiper Setting, R_{AB} Resistance, and Temperature (8-bit: $V_L = 1.8\text{V}, 2.7\text{V}, 5.5\text{V}$, $A = V^+$, $B = V^-$, $\text{DGND} = V^-$, $V^+ = 10\text{V}$).

MCP41HVX1

Note: Unless otherwise indicated, $T_A = +25^\circ\text{C}$, $V_L = 5.0\text{V}$, $\text{DGND} = V^-$, $V^+ = 36\text{V}$

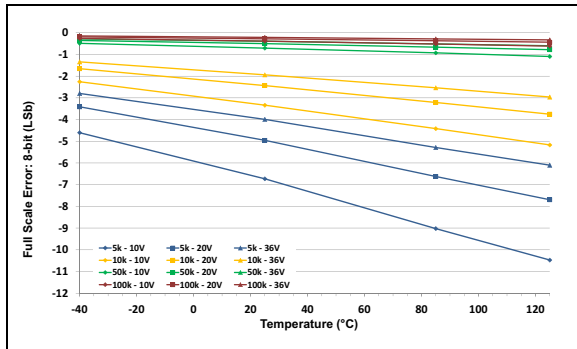

FIGURE 1-11: Full Scale Error (Pot. Mode) (FSE) vs. Temperature, R_{AB} Resistance, and V^+ Voltage (8-bit: $V_L = 1.8\text{V}, 2.7\text{V}, 5.5\text{V}$, $A = V^+, B = V^-, \text{DGND} = V^-, V^+ = 36\text{V}, 20\text{V}, 10\text{V}$).

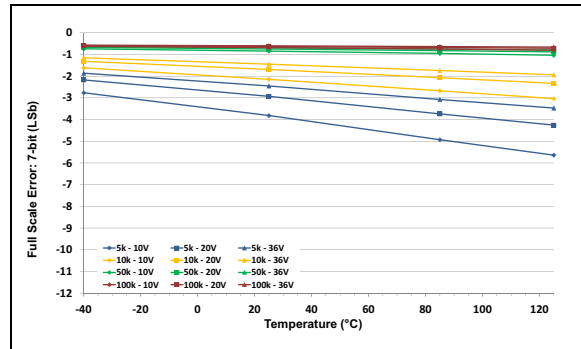

FIGURE 1-14: Full Scale Error (Pot. Mode) (FSE) vs. Temperature, R_{AB} Resistance, and V^+ Voltage (7-bit: $V_L = 1.8\text{V}, 2.7\text{V}, 5.5\text{V}$, $A = V^+, B = V^-, \text{DGND} = V^-, V^+ = 36\text{V}, 20\text{V}, 10\text{V}$).

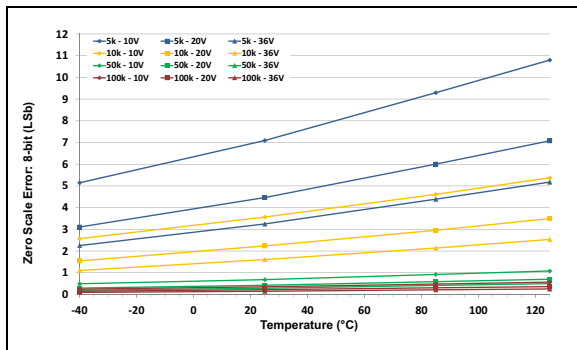

FIGURE 1-12: Zero Scale Error (Pot. Mode) (FSE) vs. Temperature, R_{AB} Resistance, and V^+ Voltage (8-bit: $V_L = 1.8\text{V}, 2.7\text{V}, 5.5\text{V}$, $A = V^+, B = V^-, \text{DGND} = V^-, V^+ = 36\text{V}, 20\text{V}, 10\text{V}$).

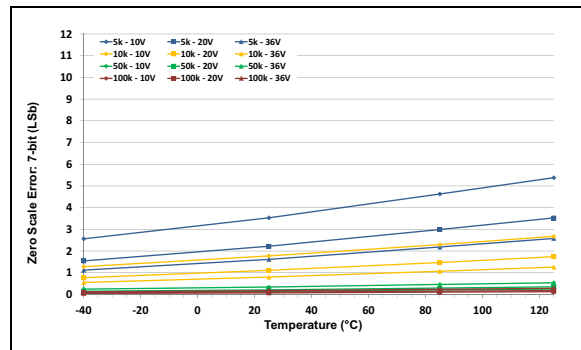

FIGURE 1-15: Zero Scale Error (Pot. Mode) (FSE) vs. Temperature, R_{AB} Resistance, and V^+ Voltage (7-bit: $V_L = 1.8\text{V}, 2.7\text{V}, 5.5\text{V}$, $A = V^+, B = V^-, \text{DGND} = V^-, V^+ = 36\text{V}, 20\text{V}, 10\text{V}$).

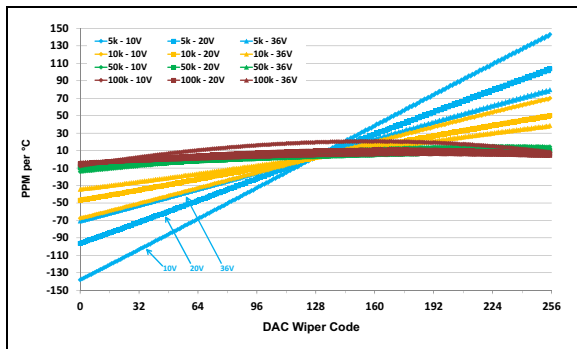

FIGURE 1-13: V_W PPM/ $^\circ\text{C}$ (Pot. Mode) vs. Temperature, R_{AB} Resistance, and V^+ Voltage $\left(\left(\frac{V_{W(\text{code}=n, 125^\circ\text{C})} - V_{W(\text{code}=n, -40^\circ\text{C})}}{V_{W(\text{code}=255, 25^\circ\text{C})}} \right) * 1,000,000 / 165^\circ\text{C} \right)$ (8-bit: $V_L = 1.8\text{V}, 2.7\text{V}, 5.5\text{V}$, $A = V^+, B = V^-, \text{DGND} = V^-, V^+ = 36\text{V}, 20\text{V}, 10\text{V}$).

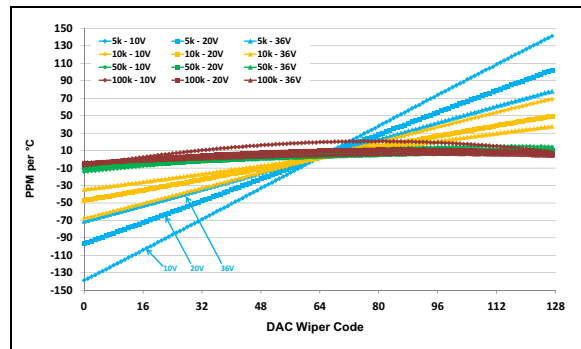

FIGURE 1-16: V_W PPM/ $^\circ\text{C}$ (Pot. Mode) vs. Temperature, R_{AB} Resistance, and V^+ Voltage $\left(\left(\frac{V_{W(\text{code}=n, 125^\circ\text{C})} - V_{W(\text{code}=n, -40^\circ\text{C})}}{V_{W(\text{code}=127, 25^\circ\text{C})}} \right) * 1,000,000 / 165^\circ\text{C} \right)$ (7-bit: $V_L = 1.8\text{V}, 2.7\text{V}, 5.5\text{V}$, $A = V^+, B = V^-, \text{DGND} = V^-, V^+ = 36\text{V}, 20\text{V}, 10\text{V}$).

Note: Unless otherwise indicated, $T_A = +25^\circ\text{C}$, $V_L = 5.0\text{V}$, $\text{DGND} = V^-$, $V^+ = 36\text{V}$.

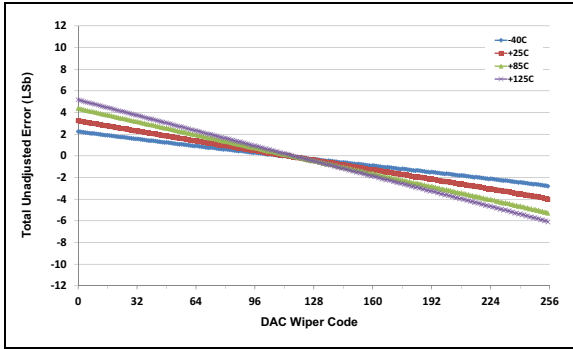

FIGURE 1-17: Total Unadjusted Error (Pot. Mode) (V_W) vs. Wiper Setting and Temperature ($5.0\text{ k}\Omega$, 8-bit: $V_L = 1.8\text{V}, 2.7\text{V}, 5.5\text{V}$, $A = V^+$, $B = V^-$, $\text{DGND} = V^-$, $V^+ = 36\text{V}$).

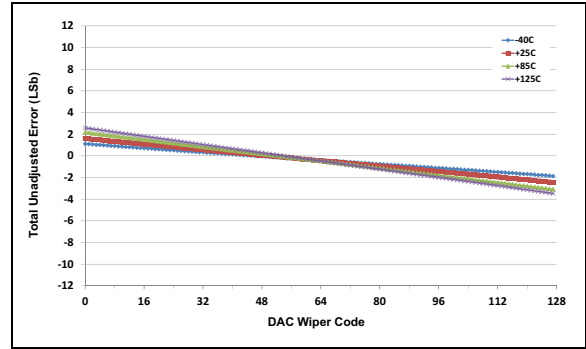

FIGURE 1-20: Total Unadjusted Error (Pot. Mode) (V_W) vs. Wiper Setting and Temperature ($5.0\text{ k}\Omega$, 7-bit: $V_L = 1.8\text{V}, 2.7\text{V}, 5.5\text{V}$, $A = V^+$, $B = V^-$, $\text{DGND} = V^-$, $V^+ = 36\text{V}$).

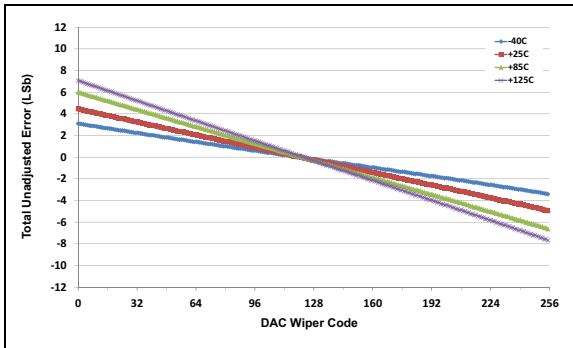

FIGURE 1-18: Total Unadjusted Error (Pot. Mode) (V_W) vs. Wiper Setting and Temperature ($5.0\text{ k}\Omega$, 8-bit: $V_L = 1.8\text{V}, 2.7\text{V}, 5.5\text{V}$, $A = V^+$, $B = V^-$, $\text{DGND} = V^-$, $V^+ = 20\text{V}$).

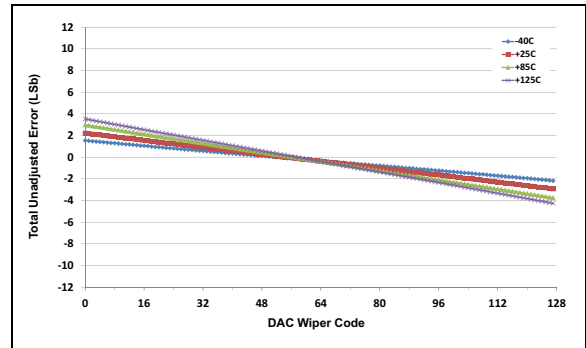

FIGURE 1-21: Total Unadjusted Error (Pot. Mode) (V_W) vs. Wiper Setting and Temperature ($5.0\text{ k}\Omega$, 7-bit: $V_L = 1.8\text{V}, 2.7\text{V}, 5.5\text{V}$, $A = V^+$, $B = V^-$, $\text{DGND} = V^-$, $V^+ = 20\text{V}$).

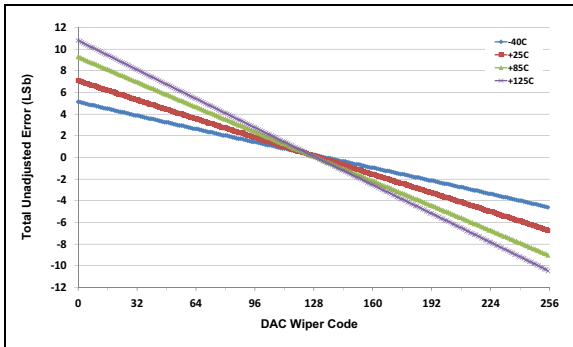

FIGURE 1-19: Total Unadjusted Error (Pot. Mode) (V_W) vs. Wiper Setting and Temperature ($5.0\text{ k}\Omega$, 8-bit: $V_L = 1.8\text{V}, 2.7\text{V}, 5.5\text{V}$, $A = V^+$, $B = V^-$, $\text{DGND} = V^-$, $V^+ = 10\text{V}$).

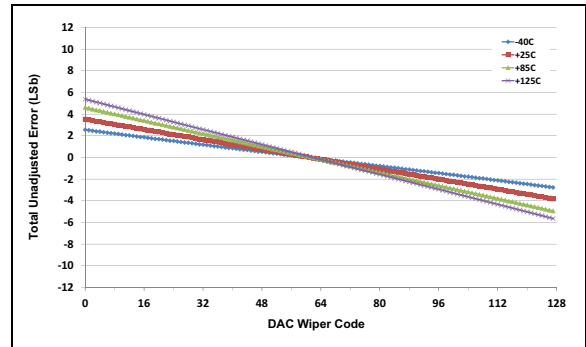

FIGURE 1-22: Total Unadjusted Error (Pot. Mode) (V_W) vs. Wiper Setting and Temperature ($5.0\text{ k}\Omega$, 7-bit: $V_L = 1.8\text{V}, 2.7\text{V}, 5.5\text{V}$, $A = V^+$, $B = V^-$, $\text{DGND} = V^-$, $V^+ = 10\text{V}$).

MCP41HVX1

Note: Unless otherwise indicated, $T_A = +25^\circ\text{C}$, $V_L = 5.0\text{V}$, $\text{DGND} = \text{V-}$, $\text{V+} = 36\text{V}$.

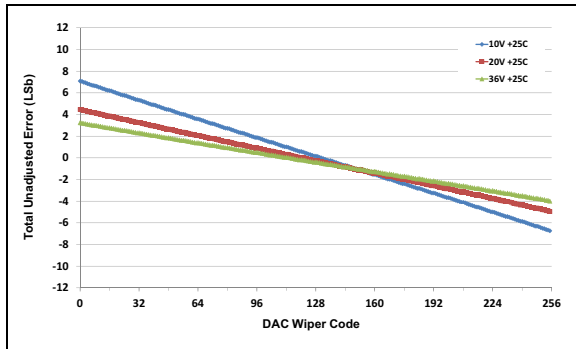

FIGURE 1-23: Total Unadjusted Error (Pot. Mode) (V_W) vs. Wiper Setting (@ 25°C) ($5.0\text{ k}\Omega$, **8-bit**: $V_L = 1.8\text{V}, 2.7\text{V}, 5.5\text{V}$, $A = \text{V+}$, $B = \text{V-}$, $\text{DGND} = \text{V-}$, $\text{V+} = 36\text{V}, 20\text{V}, 10\text{V}$).

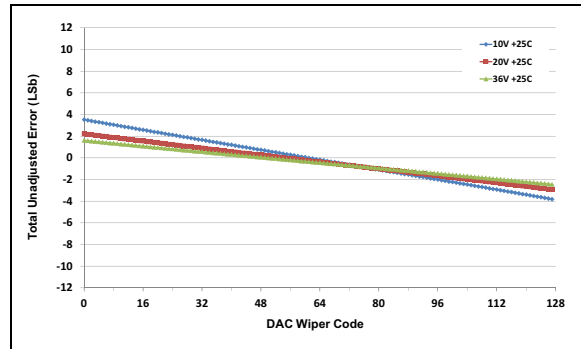

FIGURE 1-26: Total Unadjusted Error (Pot. Mode) (V_W) vs. Wiper Setting (@ 25°C) ($5.0\text{ k}\Omega$, **7-bit**: $V_L = 1.8\text{V}, 2.7\text{V}, 5.5\text{V}$, $A = \text{V+}$, $B = \text{V-}$, $\text{DGND} = \text{V-}$, $\text{V+} = 36\text{V}, 20\text{V}, 10\text{V}$).

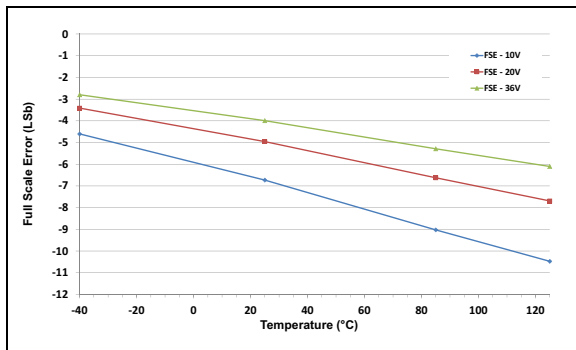

FIGURE 1-24: Full Scale Error (Pot. Mode) (FSE) vs. Temperature and $V+$ Voltage ($5.0\text{ k}\Omega$, **8-bit**: $V_L = 1.8\text{V}, 2.7\text{V}, 5.5\text{V}$, $A = \text{V+}$, $B = \text{V-}$, $\text{DGND} = \text{V-}$, $\text{V+} = 36\text{V}, 20\text{V}, 10\text{V}$).

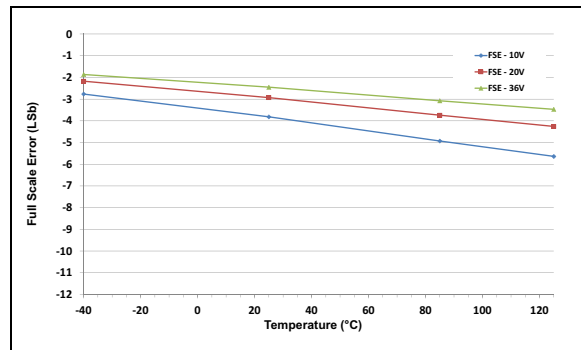

FIGURE 1-27: Full Scale Error (Pot. Mode) (FSE) vs. Temperature and $V+$ Voltage ($5.0\text{ k}\Omega$, **7-bit**: $V_L = 1.8\text{V}, 2.7\text{V}, 5.5\text{V}$, $A = \text{V+}$, $B = \text{V-}$, $\text{DGND} = \text{V-}$, $\text{V+} = 36\text{V}, 20\text{V}, 10\text{V}$).

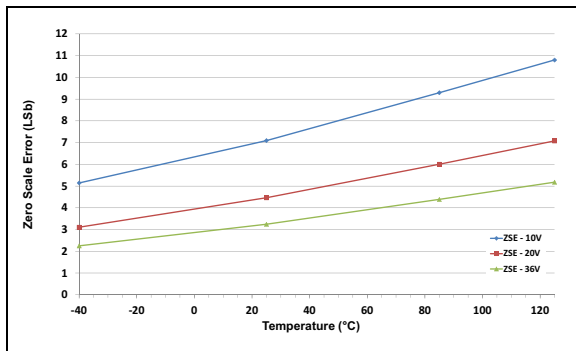

FIGURE 1-25: Zero Scale Error (Pot. Mode) (ZSE) vs. Temperature and $V+$ Voltage ($5.0\text{ k}\Omega$, **8-bit**: $V_L = 1.8\text{V}, 2.7\text{V}, 5.5\text{V}$, $A = \text{V+}$, $B = \text{V-}$, $\text{DGND} = \text{V-}$, $\text{V+} = 36\text{V}, 20\text{V}, 10\text{V}$).

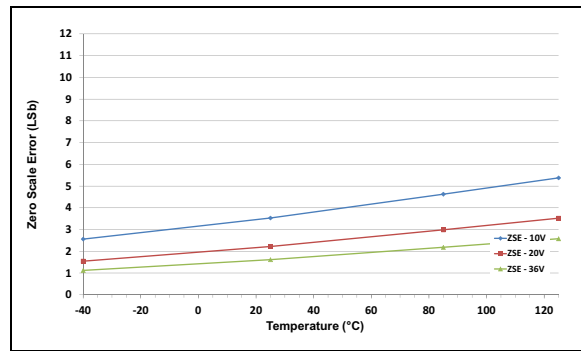

FIGURE 1-28: Zero Scale Error (Pot. Mode) (ZSE) vs. Temperature and $V+$ Voltage ($5.0\text{ k}\Omega$, **7-bit**: $V_L = 1.8\text{V}, 2.7\text{V}, 5.5\text{V}$, $A = \text{V+}$, $B = \text{V-}$, $\text{DGND} = \text{V-}$, $\text{V+} = 36\text{V}, 20\text{V}, 10\text{V}$).

Note: Unless otherwise indicated, $T_A = +25^\circ\text{C}$, $V_L = 5.0\text{V}$, $\text{DGND} = V^-$, $V^+ = 36\text{V}$.

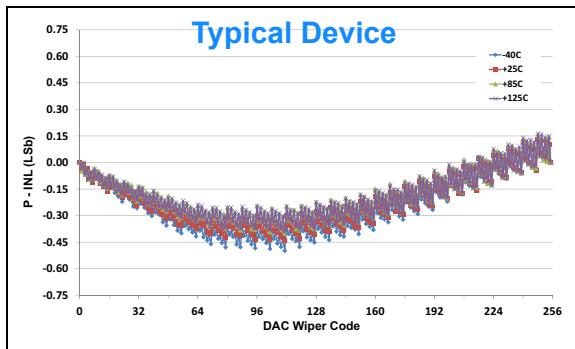

FIGURE 1-29: INL Error - Pot. Mode (P-INL) vs. Wiper Setting and Temperature (**5.0 kΩ, 8-bit**: $V_L = 1.8\text{V}, 2.7\text{V}, 5.5\text{V}$, $A = V^+$, $B = V^-$, $\text{DGND} = V^-$, **$V^+ = 36\text{V}$**).

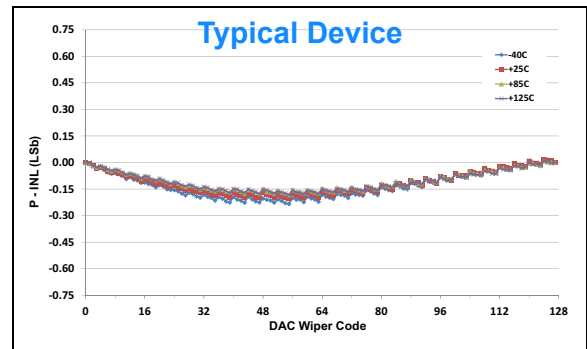

FIGURE 1-32: INL Error - Pot. Mode (P-INL) vs. Wiper Setting and Temperature (**5.0 kΩ, 7-bit**: $V_L = 1.8\text{V}, 2.7\text{V}, 5.5\text{V}$, $A = V^+$, $B = V^-$, $\text{DGND} = V^-$, **$V^+ = 36\text{V}$**).

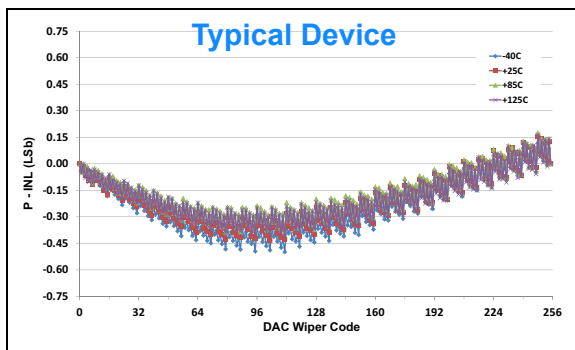

FIGURE 1-30: INL Error - Pot. Mode (P-INL) vs. Wiper Setting and Temperature (**5.0 kΩ, 8-bit**: $V_L = 1.8\text{V}, 2.7\text{V}, 5.5\text{V}$, $A = V^+$, $B = V^-$, $\text{DGND} = V^-$, **$V^+ = 20\text{V}$**).

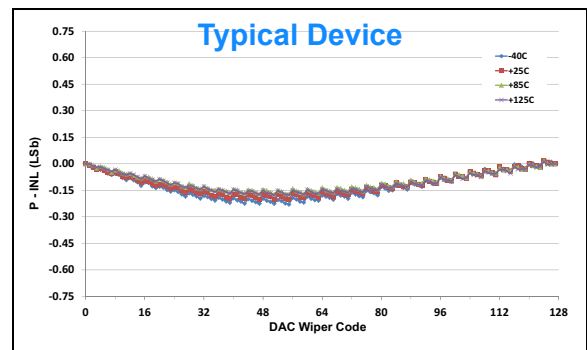

FIGURE 1-33: INL Error - Pot. Mode (P-INL) vs. Wiper Setting and Temperature (**5.0 kΩ, 7-bit**: $V_L = 1.8\text{V}, 2.7\text{V}, 5.5\text{V}$, $A = V^+$, $B = V^-$, $\text{DGND} = V^-$, **$V^+ = 20\text{V}$**).

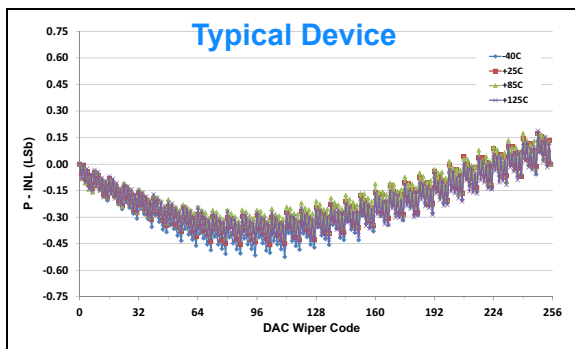

FIGURE 1-31: INL Error - Pot. Mode (P-INL) vs. Wiper Setting and Temperature (**5.0 kΩ, 8-bit**: $V_L = 1.8\text{V}, 2.7\text{V}, 5.5\text{V}$, $A = V^+$, $B = V^-$, $\text{DGND} = V^-$, **$V^+ = 10\text{V}$**).

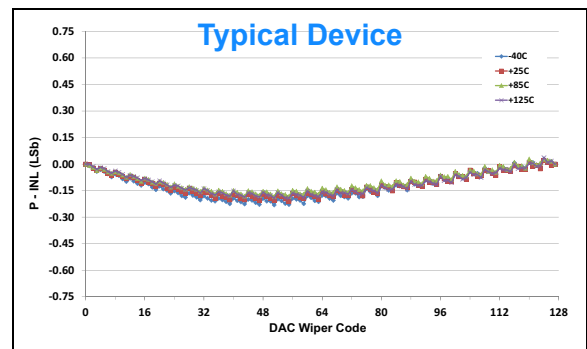

FIGURE 1-34: INL Error - Pot. Mode (P-INL) vs. Wiper Setting and Temperature (**5.0 kΩ, 7-bit**: $V_L = 1.8\text{V}, 2.7\text{V}, 5.5\text{V}$, $A = V^+$, $B = V^-$, $\text{DGND} = V^-$, **$V^+ = 10\text{V}$**).

MCP41HVX1

Note: Unless otherwise indicated, $T_A = +25^\circ\text{C}$, $V_L = 5.0\text{V}$, $\text{DGND} = \text{V-}$, $\text{V+} = 36\text{V}$.

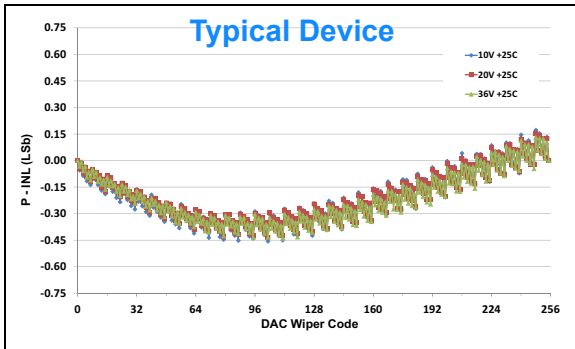

FIGURE 1-35: INL Error - Pot. Mode (P-INL) vs. Wiper Setting (@ 25°C)
($5.0\text{ k}\Omega$, 8-bit: $V_L = 1.8\text{V}, 2.7\text{V}, 5.5\text{V}$,
 $A = \text{V+}$, $B = \text{V-}$, $\text{DGND} = \text{V-}$, $\text{V+} = 36\text{V}, 20\text{V}, 10\text{V}$).

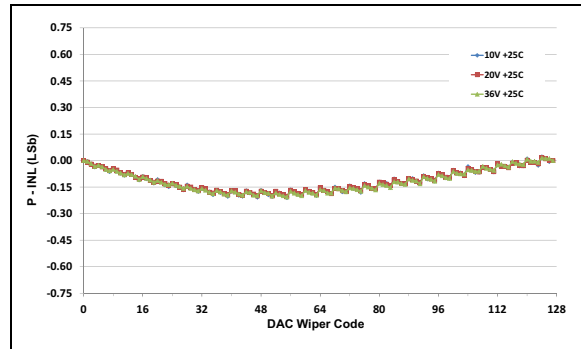

FIGURE 1-36: INL Error - Pot. Mode (P-INL) vs. Wiper Setting (@ 25°C)
($5.0\text{ k}\Omega$, 7-bit: $V_L = 1.8\text{V}, 2.7\text{V}, 5.5\text{V}$,
 $A = \text{V+}$, $B = \text{V-}$, $\text{DGND} = \text{V-}$, $\text{V+} = 36\text{V}, 20\text{V}, 10\text{V}$).

Note: Unless otherwise indicated, $T_A = +25^\circ\text{C}$, $V_L = 5.0\text{V}$, $\text{DGND} = V_-$, $V_+ = 36\text{V}$.

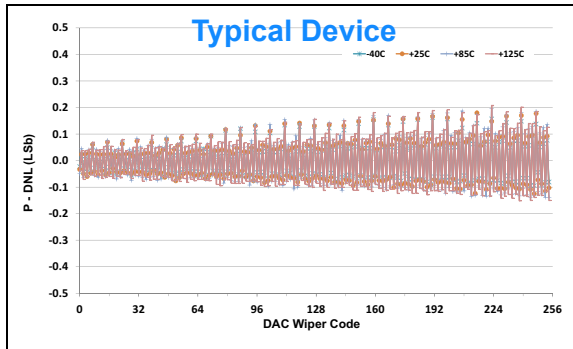

FIGURE 1-37: DNL Error - Pot. Mode (P-DNL) vs. Wiper Setting and Temperature (**5.0 kΩ, 8-bit**: $V_L = 1.8\text{V}, 2.7\text{V}, 5.5\text{V}$, $A = V_+$, $B = V_-$, $\text{DGND} = V_-$, **$V_+ = 36\text{V}$**).

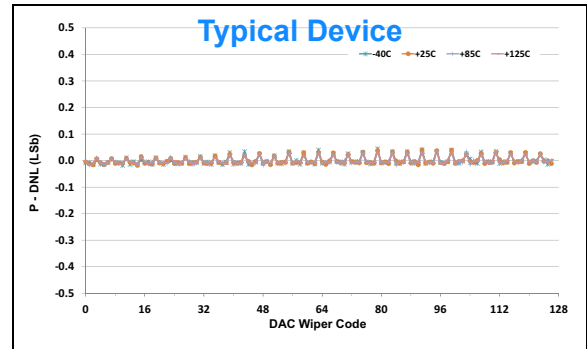

FIGURE 1-40: DNL Error - Pot. Mode (P-DNL) vs. Wiper Setting and Temperature (**5.0 kΩ, 7-bit**: $V_L = 1.8\text{V}, 2.7\text{V}, 5.5\text{V}$, $A = V_+$, $B = V_-$, $\text{DGND} = V_-$, **$V_+ = 36\text{V}$**).

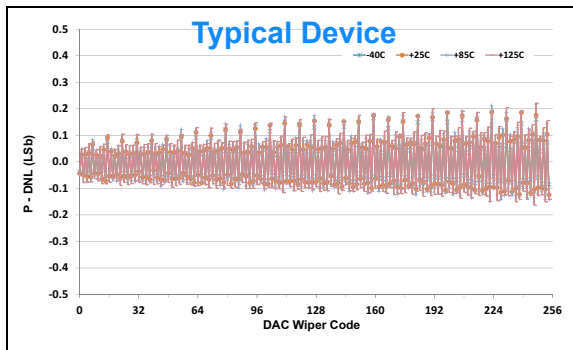

FIGURE 1-38: DNL Error - Pot. Mode (P-DNL) vs. Wiper Setting and Temperature (**5.0 kΩ, 8-bit**: $V_L = 1.8\text{V}, 2.7\text{V}, 5.5\text{V}$, $A = V_+$, $B = V_-$, $\text{DGND} = V_-$, **$V_+ = 20\text{V}$**).

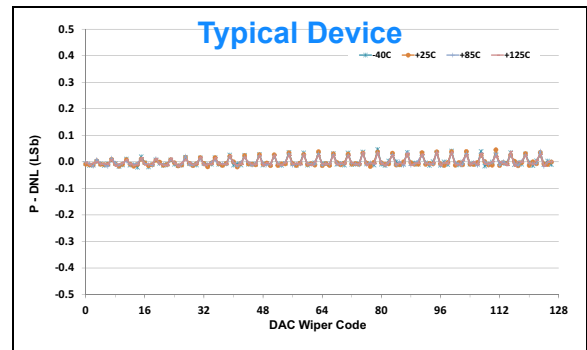

FIGURE 1-41: DNL Error - Pot. Mode (P-DNL) vs. Wiper Setting and Temperature (**5.0 kΩ, 7-bit**: $V_L = 1.8\text{V}, 2.7\text{V}, 5.5\text{V}$, $A = V_+$, $B = V_-$, $\text{DGND} = V_-$, **$V_+ = 20\text{V}$**).

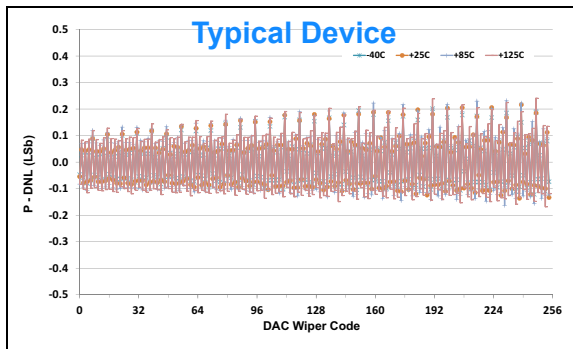

FIGURE 1-39: DNL Error - Pot. Mode (P-DNL) vs. Wiper Setting and Temperature (**5.0 kΩ, 8-bit**: $V_L = 1.8\text{V}, 2.7\text{V}, 5.5\text{V}$, $A = V_+$, $B = V_-$, $\text{DGND} = V_-$, **$V_+ = 10\text{V}$**).

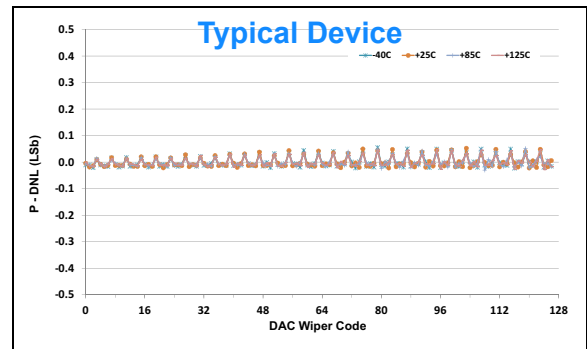

FIGURE 1-42: DNL Error - Pot. Mode (P-DNL) vs. Wiper Setting and Temperature (**5.0 kΩ, 7-bit**: $V_L = 1.8\text{V}, 2.7\text{V}, 5.5\text{V}$, $A = V_+$, $B = V_-$, $\text{DGND} = V_-$, **$V_+ = 10\text{V}$**).

MCP41HVX1

Note: Unless otherwise indicated, $T_A = +25^\circ\text{C}$, $V_L = 5.0\text{V}$, $\text{DGND} = V^-$, $V^+ = 36\text{V}$.

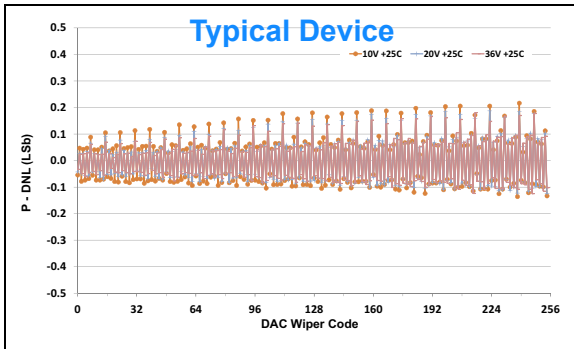

FIGURE 1-43: DNL Error - Pot. Mode (P-DNL) vs. Wiper Setting (@ 25°C) ($5.0\text{ k}\Omega$, **8-bit**: $V_L = 1.8\text{V}, 2.7\text{V}, 5.5\text{V}$, $A = V^+$, $B = V^-$, $\text{DGND} = V^-$, $V^+ = 36\text{V}, 20\text{V}, 10\text{V}$).

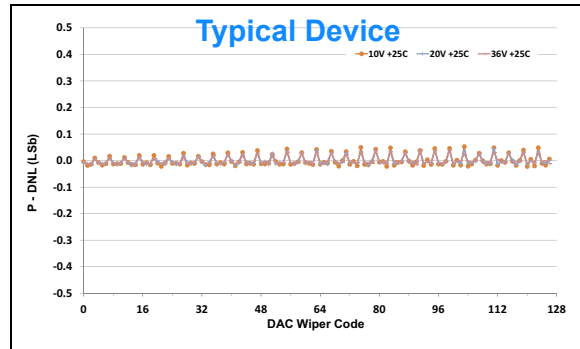

FIGURE 1-44: DNL Error - Pot. Mode (P-DNL) vs. Wiper Setting (@ 25°C) ($5.0\text{ k}\Omega$, **7-bit**: $V_L = 1.8\text{V}, 2.7\text{V}, 5.5\text{V}$, $A = V^+$, $B = V^-$, $\text{DGND} = V^-$, $V^+ = 36\text{V}, 20\text{V}, 10\text{V}$).

Note: Unless otherwise indicated, $T_A = +25^\circ\text{C}$, $V_L = 5.0\text{V}$, $\text{DGND} = V^-$, $V^+ = 36\text{V}$.

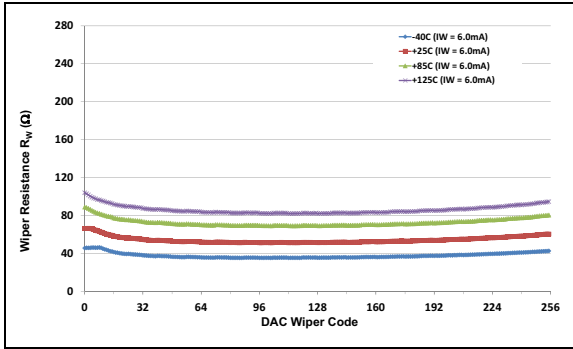

FIGURE 1-45: Wiper Resistance (R_W) vs. Wiper Setting and Temperature (**5.0 kΩ, 8-bit**: $V_L = 1.8\text{V}, 2.7\text{V}, 5.5\text{V}$, $A = V^+$, $B = V^-$, $\text{DGND} = V^-$, **$V^+ = 36\text{V}$** , **$I_W = 6.0\text{mA}$**).

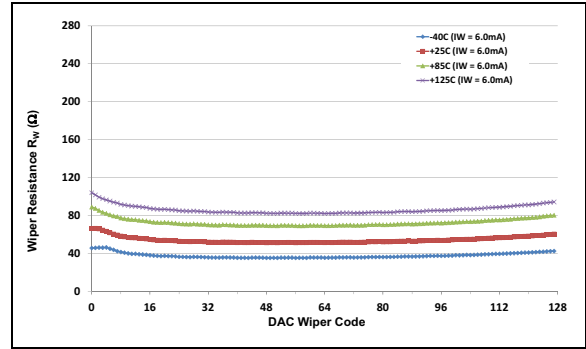

FIGURE 1-48: Wiper Resistance (R_W) vs. Wiper Setting and Temperature (**5.0 kΩ, 7-bit**: $V_L = 1.8\text{V}, 2.7\text{V}, 5.5\text{V}$, $A = V^+$, $B = V^-$, $\text{DGND} = V^-$, **$V^+ = 36\text{V}$** , **$I_W = 6.0\text{mA}$**).

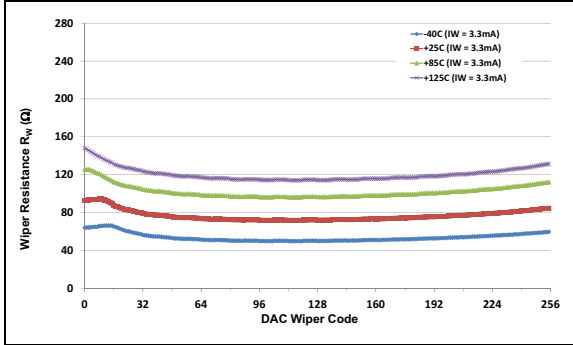

FIGURE 1-46: Wiper Resistance (R_W) vs. Wiper Setting and Temperature (**5.0 kΩ, 8-bit**: $V_L = 1.8\text{V}, 2.7\text{V}, 5.5\text{V}$, $A = V^+$, $B = V^-$, $\text{DGND} = V^-$, **$V^+ = 20\text{V}$** , **$I_W = 3.3\text{mA}$**).

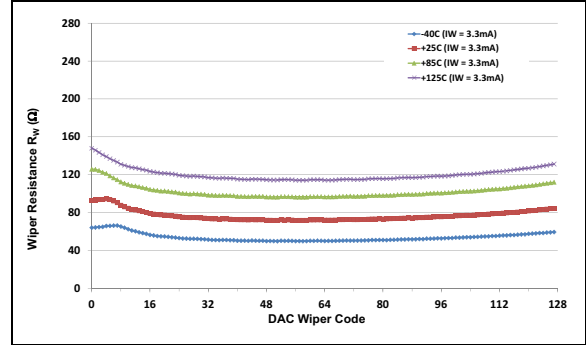

FIGURE 1-49: Wiper Resistance (R_W) vs. Wiper Setting and Temperature (**5.0 kΩ, 7-bit**: $V_L = 1.8\text{V}, 2.7\text{V}, 5.5\text{V}$, $A = V^+$, $B = V^-$, $\text{DGND} = V^-$, **$V^+ = 20\text{V}$** , **$I_W = 3.3\text{mA}$**).

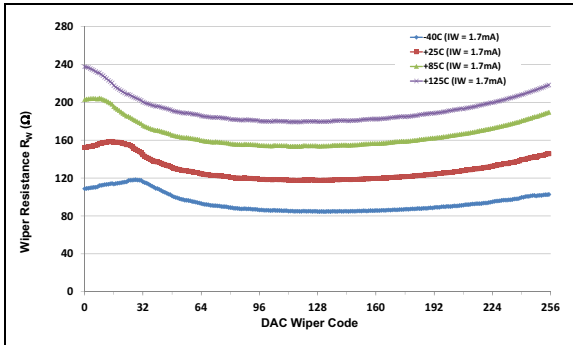

FIGURE 1-47: Wiper Resistance (R_W) vs. Wiper Setting and Temperature (**5.0 kΩ, 8-bit**: $V_L = 1.8\text{V}, 2.7\text{V}, 5.5\text{V}$, $A = V^+$, $B = V^-$, $\text{DGND} = V^-$, **$V^+ = 10\text{V}$** , **$I_W = 1.7\text{mA}$**).

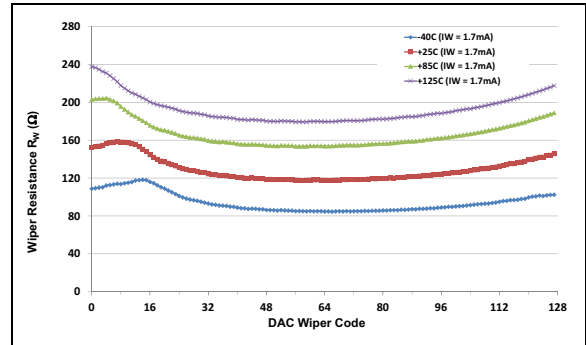

FIGURE 1-50: Wiper Resistance (R_W) vs. Wiper Setting and Temperature (**5.0 kΩ, 7-bit**: $V_L = 1.8\text{V}, 2.7\text{V}, 5.5\text{V}$, $A = V^+$, $B = V^-$, $\text{DGND} = V^-$, **$V^+ = 10\text{V}$** , **$I_W = 1.7\text{mA}$**).

MCP41HVX1

Note: Unless otherwise indicated, $T_A = +25^\circ\text{C}$, $V_L = 5.0\text{V}$, $\text{DGND} = V_-$, $V_+ = 36\text{V}$

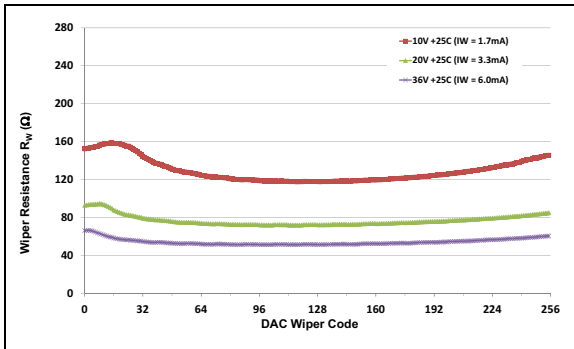

FIGURE 1-51: Wiper Resistance (R_W) vs. Wiper Setting @ 29°C
 ($5.0\text{ k}\Omega$, **8-bit**: $V_L = 1.8\text{V}, 2.7\text{V}, 5.5\text{V}$,
 $A = V_+$, $B = V_-$, $\text{DGND} = V_-$,
 $V_+ = 36\text{V}$ and $I_W = 6.0\text{mA}$, $V_+ = 20\text{V}$ and
 $I_W = 3.3\text{mA}$, $V_+ = 10\text{V}$ and $I_W = 1.7\text{mA}$).

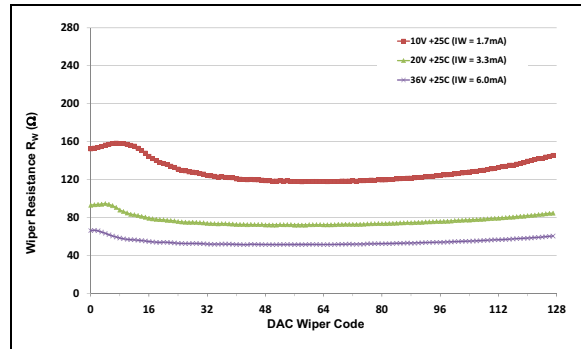

FIGURE 1-52: Wiper Resistance (R_W) vs. Wiper Setting @ 29°C
 ($5.0\text{ k}\Omega$, **7-bit**: $V_L = 1.8\text{V}, 2.7\text{V}, 5.5\text{V}$,
 $V_+ = 36\text{V}$ and $I_W = 6.0\text{mA}$, $V_+ = 20\text{V}$ and
 $I_W = 3.3\text{mA}$, $V_+ = 10\text{V}$ and $I_W = 1.7\text{mA}$).

Note: Unless otherwise indicated, $T_A = +25^\circ\text{C}$, $V_L = 5.0\text{V}$, $\text{DGND} = V_-$, $V_+ = 36\text{V}$.

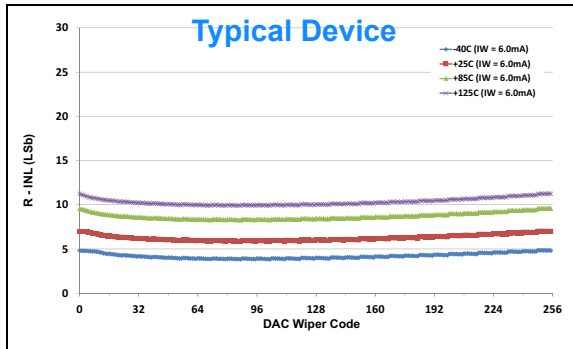

FIGURE 1-53: INL Error - Rheo. Mode (R-INL) vs. Wiper Setting and Temperature ($5.0\text{ k}\Omega$, 8-bit: $V_L = 1.8\text{V}, 2.7\text{V}, 5.5\text{V}$, $A = V_+$, $B = V_-$, $\text{DGND} = V_-$, $V_+ = 36\text{V}$, $I_W = 6.0\text{ mA}$).

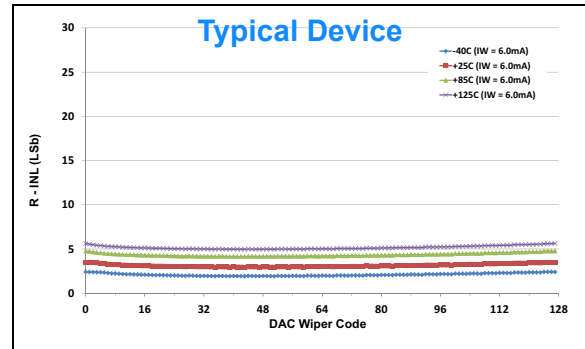

FIGURE 1-56: INL Error - Rheo. Mode (R-INL) vs. Wiper Setting and Temperature ($5.0\text{ k}\Omega$, 7-bit: $V_L = 1.8\text{V}, 2.7\text{V}, 5.5\text{V}$, $A = V_+$, $B = V_-$, $\text{DGND} = V_-$, $V_+ = 36\text{V}$, $I_W = 6.0\text{ mA}$).

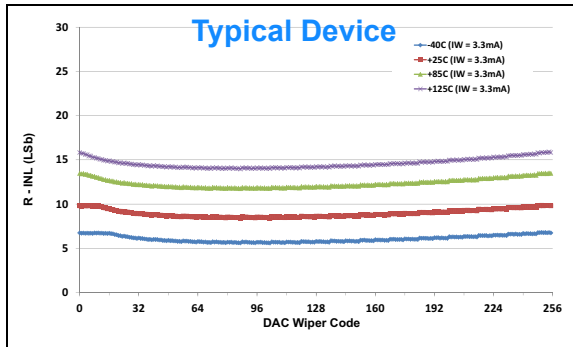

FIGURE 1-54: INL Error - Rheo. Mode (R-INL) vs. Wiper Setting and Temperature ($5.0\text{ k}\Omega$, 8-bit: $V_L = 1.8\text{V}, 2.7\text{V}, 5.5\text{V}$, $A = V_+$, $B = V_-$, $\text{DGND} = V_-$, $V_+ = 20\text{V}$, $I_W = 3.3\text{ mA}$).

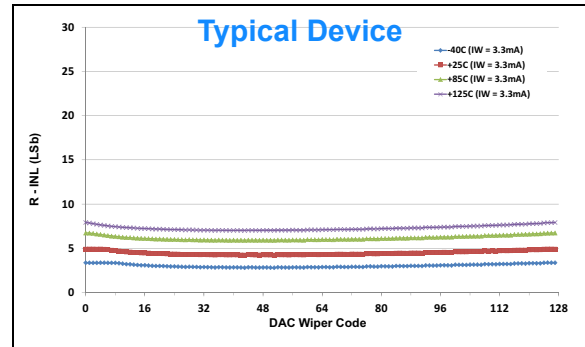

FIGURE 1-57: INL Error - Rheo. Mode (R-INL) vs. Wiper Setting and Temperature ($5.0\text{ k}\Omega$, 7-bit: $V_L = 1.8\text{V}, 2.7\text{V}, 5.5\text{V}$, $A = V_+$, $B = V_-$, $\text{DGND} = V_-$, $V_+ = 20\text{V}$, $I_W = 3.3\text{ mA}$).

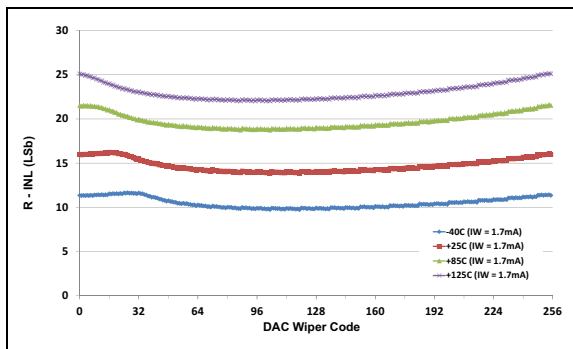

FIGURE 1-55: INL Error - Rheo. Mode (R-INL) vs. Wiper Setting and Temperature ($5.0\text{ k}\Omega$, 8-bit: $V_L = 1.8\text{V}, 2.7\text{V}, 5.5\text{V}$, $A = V_+$, $B = V_-$, $\text{DGND} = V_-$, $V_+ = 10\text{V}$, $I_W = 1.7\text{ mA}$).

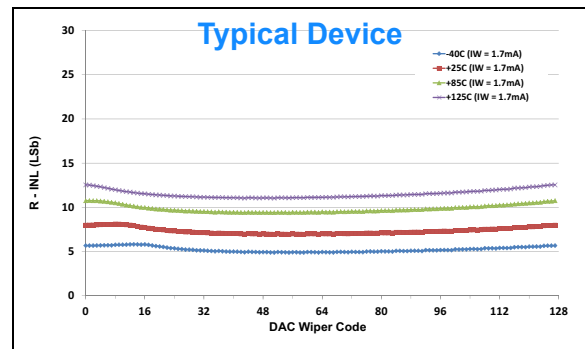

FIGURE 1-58: INL Error - Rheo. Mode (R-INL) vs. Wiper Setting and Temperature ($5.0\text{ k}\Omega$, 7-bit: $V_L = 1.8\text{V}, 2.7\text{V}, 5.5\text{V}$, $A = V_+$, $B = V_-$, $\text{DGND} = V_-$, $V_+ = 10\text{V}$, $I_W = 1.7\text{ mA}$).

MCP41HVX1

Note: Unless otherwise indicated, $T_A = +25^\circ\text{C}$, $V_L = 5.0\text{V}$, $\text{DGND} = V_-$, $V_+ = 36\text{V}$.

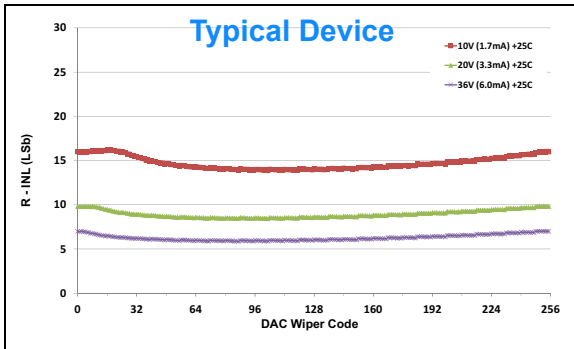

FIGURE 1-59: INL Error - Rheo. Mode (R-INL) vs. Wiper Setting (@ 25°C) ($5.0\text{ k}\Omega$, **8-bit**: $V_L = 1.8\text{V}, 2.7\text{V}, 5.5\text{V}$, $A = V_+$, $B = V_-$, $\text{DGND} = V_-$, $V_+ = 36\text{V}$ and $I_W = 6.0\text{ mA}$, $V_+ = 20\text{V}$ and $I_W = 3.3\text{ mA}$, $V_+ = 10\text{V}$ and $I_W = 1.7\text{ mA}$).

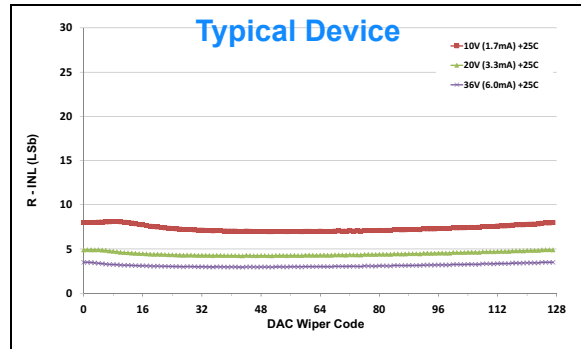

FIGURE 1-60: INL Error - Rheo. Mode (R-INL) vs. Wiper Setting (@ 25°C) ($5.0\text{ k}\Omega$, **7-bit**: $V_L = 1.8\text{V}, 2.7\text{V}, 5.5\text{V}$, $A = V_+$, $B = V_-$, $\text{DGND} = V_-$, $V_+ = 36\text{V}$ and $I_W = 6.0\text{ mA}$, $V_+ = 20\text{V}$ and $I_W = 3.3\text{ mA}$, $V_+ = 10\text{V}$ and $I_W = 1.7\text{ mA}$).

Note: Unless otherwise indicated, $T_A = +25^\circ\text{C}$, $V_L = 5.0\text{V}$, $\text{DGND} = V_-$, $V_+ = 36\text{V}$.

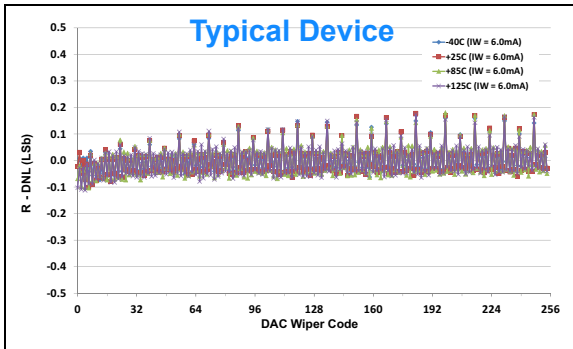

FIGURE 1-61: DNL Error - Rheo. Mode (R-DNL) vs. Wiper Setting and Temperature (**5.0 kΩ, 8-bit**: $V_L = 1.8\text{V}, 2.7\text{V}, 5.5\text{V}$, $A = V_+$, $B = V_-$, $\text{DGND} = V_-$, **$V_+ = 36\text{V}$** , **$I_W = 6.0\text{ mA}$**).

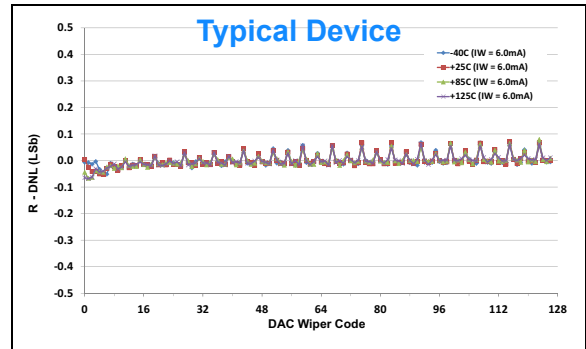

FIGURE 1-64: DNL Error - Rheo. Mode (R-DNL) vs. Wiper Setting and Temperature (**5.0 kΩ, 7-bit**: $V_L = 1.8\text{V}, 2.7\text{V}, 5.5\text{V}$, $A = V_+$, $B = V_-$, $\text{DGND} = V_-$, **$V_+ = 36\text{V}$** , **$I_W = 6.0\text{ mA}$**).

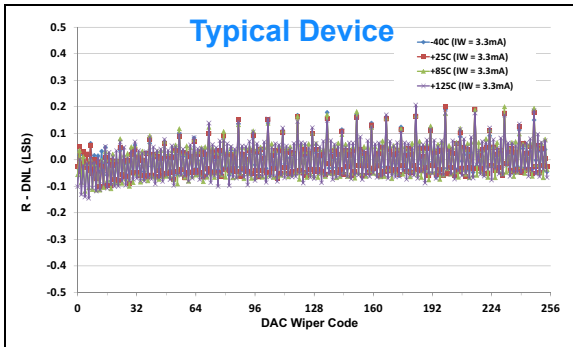

FIGURE 1-62: DNL Error - Rheo. Mode (R-DNL) vs. Wiper Setting and Temperature (**5.0 kΩ, 8-bit**: $V_L = 1.8\text{V}, 2.7\text{V}, 5.5\text{V}$, $A = V_+$, $B = V_-$, $\text{DGND} = V_-$, **$V_+ = 20\text{V}$** , **$I_W = 3.3\text{ mA}$**).

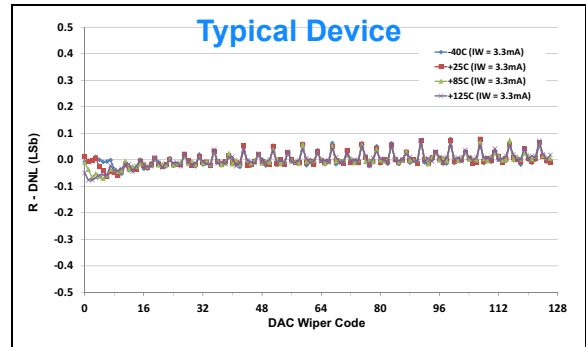

FIGURE 1-65: DNL Error - Rheo. Mode (R-DNL) vs. Wiper Setting and Temperature (**5.0 kΩ, 7-bit**: $V_L = 1.8\text{V}, 2.7\text{V}, 5.5\text{V}$, $A = V_+$, $B = V_-$, $\text{DGND} = V_-$, **$V_+ = 20\text{V}$** , **$I_W = 3.3\text{ mA}$**).

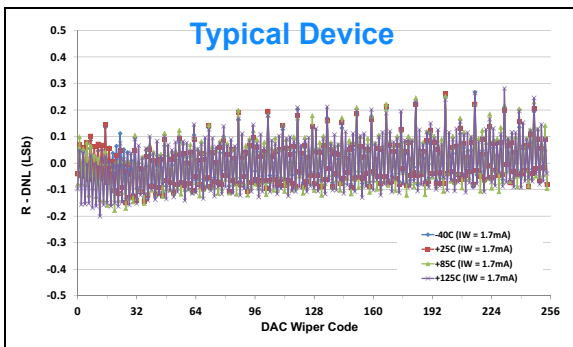

FIGURE 1-63: DNL Error - Rheo. Mode (R-DNL) vs. Wiper Setting and Temperature (**5.0 kΩ, 8-bit**: $V_L = 1.8\text{V}, 2.7\text{V}, 5.5\text{V}$, $A = V_+$, $B = V_-$, $\text{DGND} = V_-$, **$V_+ = 10\text{V}$** , **$I_W = 1.7\text{ mA}$**).

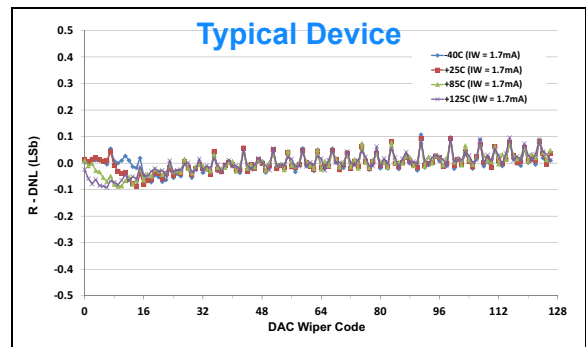

FIGURE 1-66: DNL Error - Rheo. Mode (R-DNL) vs. Wiper Setting and Temperature (**5.0 kΩ, 7-bit**: $V_L = 1.8\text{V}, 2.7\text{V}, 5.5\text{V}$, $A = V_+$, $B = V_-$, $\text{DGND} = V_-$, **$V_+ = 10\text{V}$** , **$I_W = 1.7\text{ mA}$**).

MCP41HVX1

Note: Unless otherwise indicated, $T_A = +25^\circ\text{C}$, $V_L = 5.0\text{V}$, $\text{DGND} = V_-$, $V_+ = 36\text{V}$.

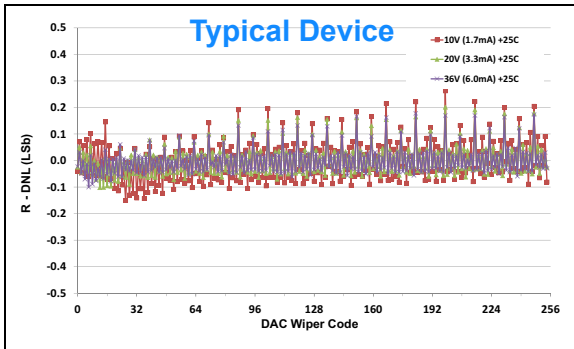

FIGURE 1-67: DNL Error - Rheo. Mode (R-DNL) vs. Wiper Setting (@ 25°C) ($5.0\text{ k}\Omega$, **8-bit**: $V_L = 1.8\text{V}, 2.7\text{V}, 5.5\text{V}$, $A = V_+$, $B = V_-$, $\text{DGND} = V_-$, $V_+ = 36\text{V}$ and $I_W = 6.0\text{ mA}$, $V_+ = 20\text{V}$ and $I_W = 3.3\text{ mA}$, $V_+ = 10\text{V}$ and $I_W = 1.7\text{ mA}$).

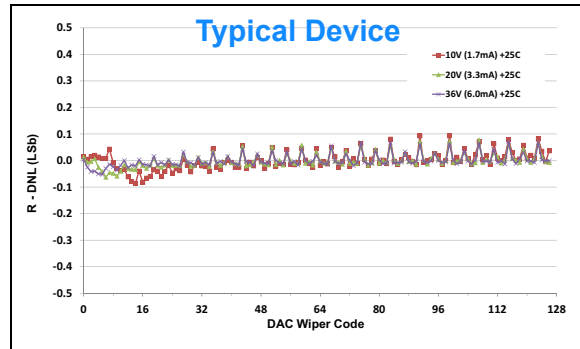

FIGURE 1-68: DNL Error - Rheo. Mode (R-DNL) vs. Wiper Setting (@ 25°C) ($5.0\text{ k}\Omega$, **7-bit**: $V_L = 1.8\text{V}, 2.7\text{V}, 5.5\text{V}$, $A = V_+$, $B = V_-$, $\text{DGND} = V_-$, $V_+ = 36\text{V}$ and $I_W = 6.0\text{ mA}$, $V_+ = 20\text{V}$ and $I_W = 3.3\text{ mA}$, $V_+ = 10\text{V}$ and $I_W = 1.7\text{ mA}$).

Note: Unless otherwise indicated, $T_A = +25^\circ\text{C}$, $V_L = 5.0\text{V}$, $\text{DGND} = V^-$, $V^+ = 36\text{V}$.

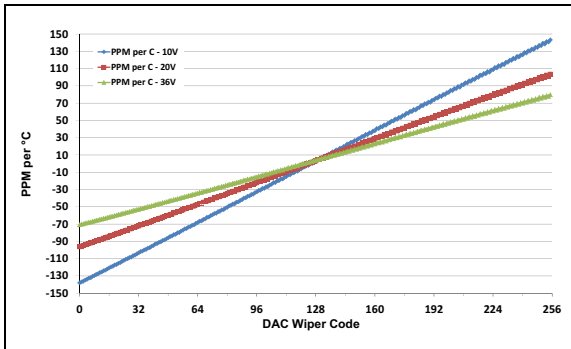

FIGURE 1-69: $V_W \text{ PPM}/^\circ\text{C}$ (Pot. Mode) vs. Temperature, and V^+ Voltage

$$\left(\frac{V_{W(\text{code}=n, 125^\circ\text{C})} - V_{W(\text{code}=n, -40^\circ\text{C})}}{V_{W(\text{code}=255, 25^\circ\text{C})}} \right) * 1,000,000 / 165^\circ\text{C}$$

(5.0 k Ω , 8-bit: $V_L = 1.8\text{V}, 2.7\text{V}, 5.5\text{V}$,
 $A = V^+, B = V^-, \text{DGND} = V^-, V^+ = 36\text{V}, 20\text{V}, 10\text{V}$).

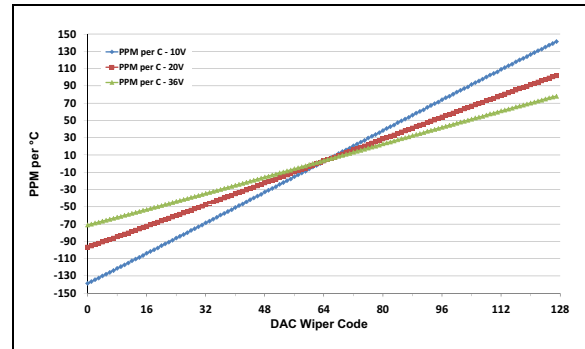

FIGURE 1-70: $V_W \text{ PPM}/^\circ\text{C}$ (Pot. Mode) vs. Temperature, and V^+ Voltage

$$\left(\frac{V_{W(\text{code}=n, 125^\circ\text{C})} - V_{W(\text{code}=n, -40^\circ\text{C})}}{V_{W(\text{code}=127, 25^\circ\text{C})}} \right) * 1,000,000 / 165^\circ\text{C}$$

(5.0 k Ω , 7-bit: $V_L = 1.8\text{V}, 2.7\text{V}, 5.5\text{V}$,
 $A = V^+, B = V^-, \text{DGND} = V^-, V^+ = 36\text{V}, 20\text{V}, 10\text{V}$).

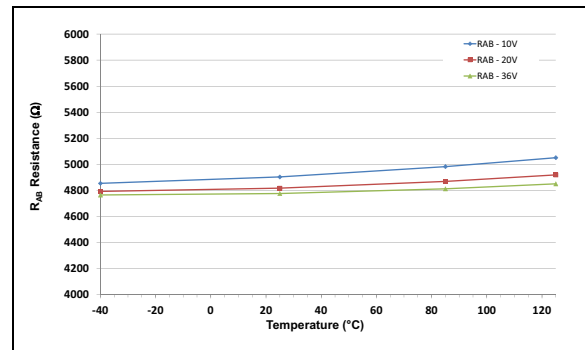

FIGURE 1-71: R_{AB} Resistance vs. Temperature and V^+ Voltage
 (5.0 k Ω : $V_L = 1.8\text{V}, 2.7\text{V}, 5.5\text{V}$,
 $A = V^+, B = V^-, \text{DGND} = V^-, V^+ = 36\text{V}, 20\text{V}, 10\text{V}$).

MCP41HVX1

Note: Unless otherwise indicated, $T_A = +25^\circ\text{C}$, $V_L = 5.0\text{V}$, $\text{DGND} = V^-$, $V^+ = 36\text{V}$.

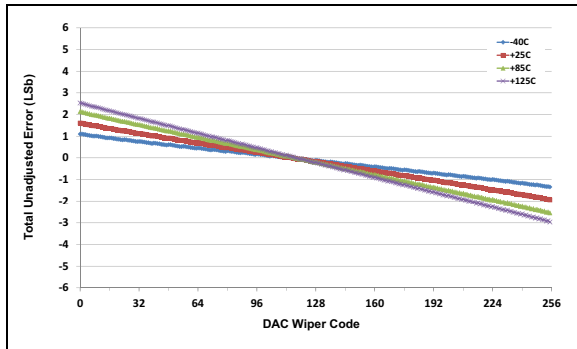

FIGURE 1-72: Total Unadjusted Error (Pot. Mode) (V_W) vs. Wiper Setting and Temperature (10.0 k Ω , 8-bit: $V_L = 1.8\text{V}$, 2.7V, 5.5V, $A = V^+$, $B = V^-$, $\text{DGND} = V^-$, $V^+ = 36\text{V}$).

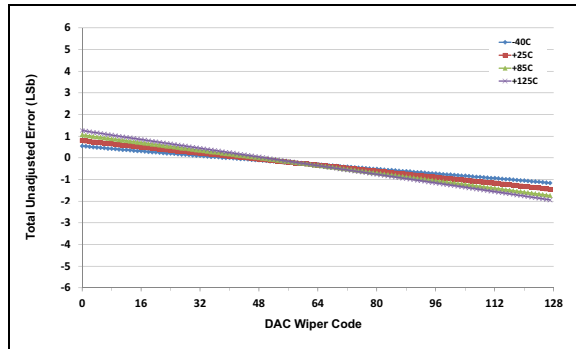

FIGURE 1-75: Total Unadjusted Error (Pot. Mode) (V_W) vs. Wiper Setting and Temperature (10.0 k Ω , 7-bit: $V_L = 1.8\text{V}$, 2.7V, 5.5V, $A = V^+$, $B = V^-$, $\text{DGND} = V^-$, $V^+ = 36\text{V}$).

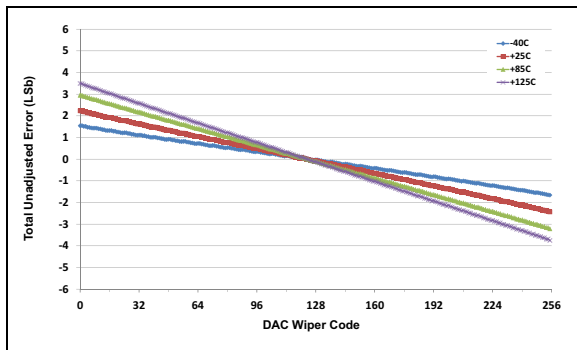

FIGURE 1-73: Total Unadjusted Error (Pot. Mode) (V_W) vs. Wiper Setting and Temperature (10.0 k Ω , 8-bit: $V_L = 1.8\text{V}$, 2.7V, 5.5V, $A = V^+$, $B = V^-$, $\text{DGND} = V^-$, $V^+ = 20\text{V}$).

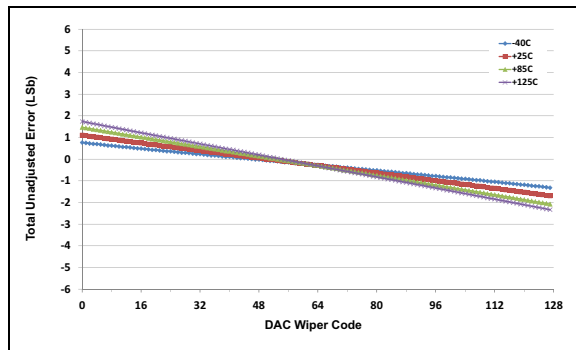

FIGURE 1-76: Total Unadjusted Error (Pot. Mode) (V_W) vs. Wiper Setting and Temperature (10.0 k Ω , 7-bit: $V_L = 1.8\text{V}$, 2.7V, 5.5V, $A = V^+$, $B = V^-$, $\text{DGND} = V^-$, $V^+ = 20\text{V}$).

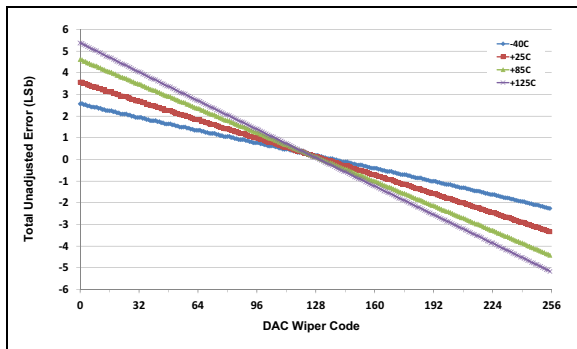

FIGURE 1-74: Total Unadjusted Error (Pot. Mode) (V_W) vs. Wiper Setting and Temperature (10.0 k Ω , 8-bit: $V_L = 1.8\text{V}$, 2.7V, 5.5V, $A = V^+$, $B = V^-$, $\text{DGND} = V^-$, $V^+ = 10\text{V}$).

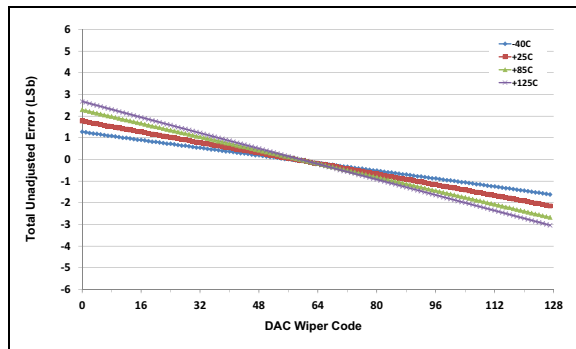

FIGURE 1-77: Total Unadjusted Error (Pot. Mode) (V_W) vs. Wiper Setting and Temperature (10.0 k Ω , 7-bit: $V_L = 1.8\text{V}$, 2.7V, 5.5V, $A = V^+$, $B = V^-$, $\text{DGND} = V^-$, $V^+ = 10\text{V}$).

Note: Unless otherwise indicated, $T_A = +25^\circ\text{C}$, $V_L = 5.0\text{V}$, $\text{DGND} = V^-$, $V^+ = 36\text{V}$.

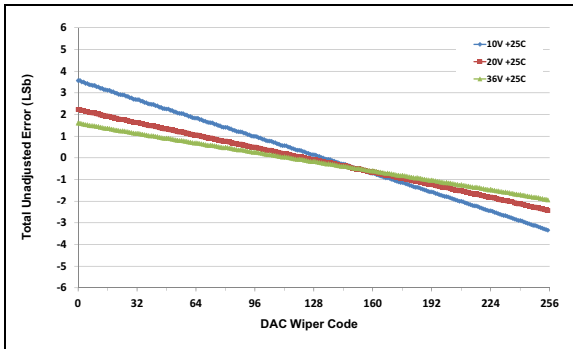

FIGURE 1-78: Total Unadjusted Error (Pot. Mode) (V_W) vs. Wiper Setting (@ 25°C) ($10.0\text{ k}\Omega$, **8-bit**: $V_L = 1.8\text{V}, 2.7\text{V}, 5.5\text{V}$, $A = V^+$, $B = V^-$, $\text{DGND} = V^-$, $V^+ = 36\text{V}, 20\text{V}, 10\text{V}$).

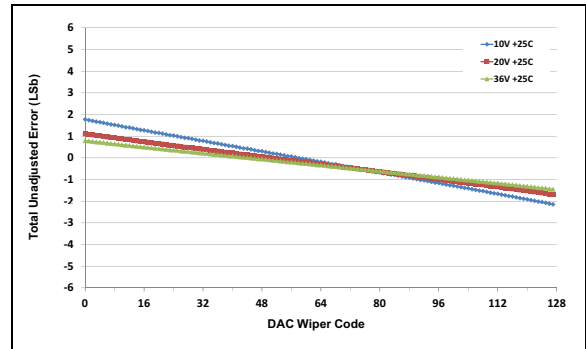

FIGURE 1-81: Total Unadjusted Error (Pot. Mode) (V_W) vs. Wiper Setting (@ 25°C) ($10.0\text{ k}\Omega$, **7-bit**: $V_L = 1.8\text{V}, 2.7\text{V}, 5.5\text{V}$, $A = V^+$, $B = V^-$, $\text{DGND} = V^-$, $V^+ = 36\text{V}, 20\text{V}, 10\text{V}$).

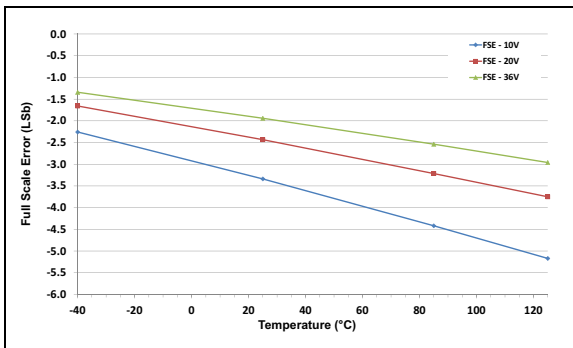

FIGURE 1-79: Full Scale Error (Pot. Mode) (FSE) vs. Temperature and V^+ Voltage ($10.0\text{ k}\Omega$, **8-bit**: $V_L = 1.8\text{V}, 2.7\text{V}, 5.5\text{V}$, $A = V^+$, $B = V^-$, $\text{DGND} = V^-$, $V^+ = 36\text{V}, 20\text{V}, 10\text{V}$).

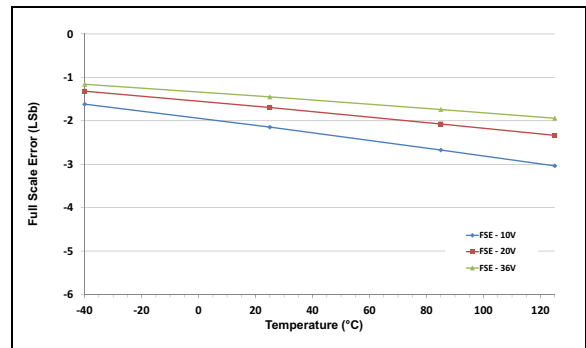

FIGURE 1-82: Full Scale Error (Pot. Mode) (FSE) vs. Temperature and V^+ Voltage ($10.0\text{ k}\Omega$, **7-bit**: $V_L = 1.8\text{V}, 2.7\text{V}, 5.5\text{V}$, $A = V^+$, $B = V^-$, $\text{DGND} = V^-$, $V^+ = 36\text{V}, 20\text{V}, 10\text{V}$).

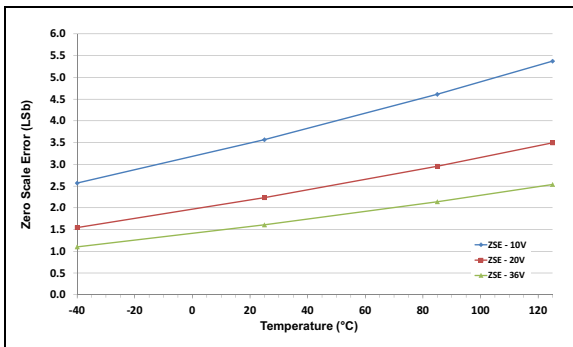

FIGURE 1-80: Zero Scale Error (Pot. Mode) (ZSE) vs. Temperature and V^+ Voltage ($10.0\text{ k}\Omega$, **8-bit**: $V_L = 1.8\text{V}, 2.7\text{V}, 5.5\text{V}$, $A = V^+$, $B = V^-$, $\text{DGND} = V^-$, $V^+ = 36\text{V}, 20\text{V}, 10\text{V}$).

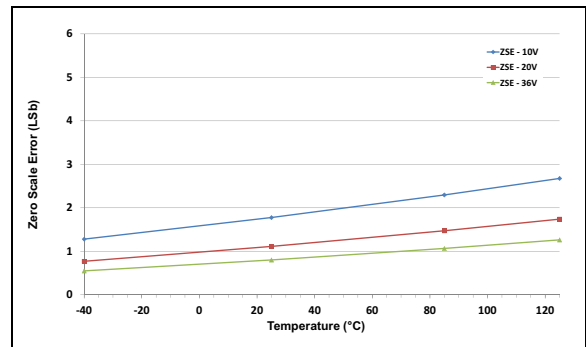

FIGURE 1-83: Zero Scale Error (Pot. Mode) (ZSE) vs. Temperature and V^+ Voltage ($10.0\text{ k}\Omega$, **7-bit**: $V_L = 1.8\text{V}, 2.7\text{V}, 5.5\text{V}$, $A = V^+$, $B = V^-$, $\text{DGND} = V^-$, $V^+ = 36\text{V}, 20\text{V}, 10\text{V}$).

MCP41HVX1

Note: Unless otherwise indicated, $T_A = +25^\circ\text{C}$, $V_L = 5.0\text{V}$, $\text{DGND} = V^-$, $V^+ = 36\text{V}$.

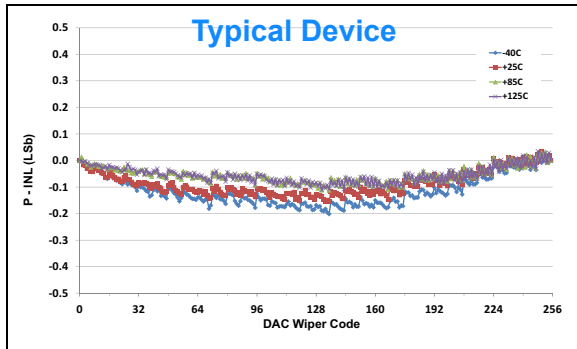

FIGURE 1-84: INL Error - Pot. Mode (P-INL) vs. Wiper Setting and Temperature (10.0 kΩ, 8-bit: $V_L = 1.8\text{V}$, 2.7V, 5.5V, $A = V^+$, $B = V^-$, $\text{DGND} = V^-$, $V^+ = 36\text{V}$).

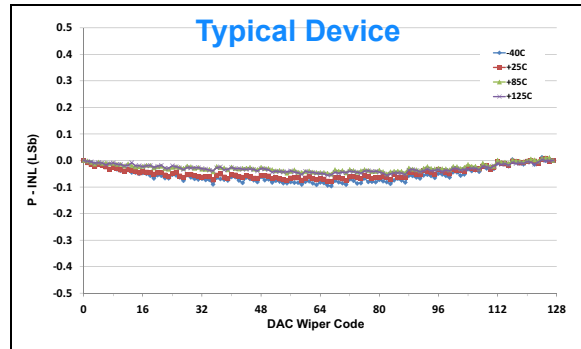

FIGURE 1-87: INL Error - Pot. Mode (P-INL) vs. Wiper Setting and Temperature (10.0 kΩ, 7-bit: $V_L = 1.8\text{V}$, 2.7V, 5.5V, $A = V^+$, $B = V^-$, $\text{DGND} = V^-$, $V^+ = 36\text{V}$).

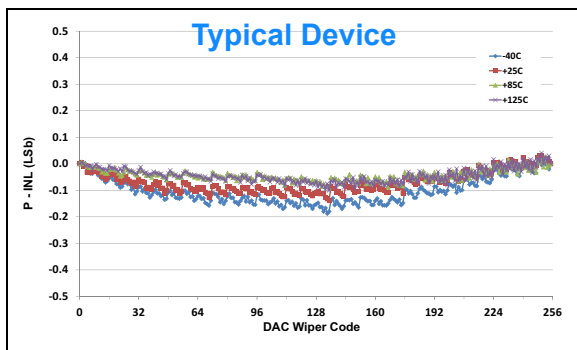

FIGURE 1-85: INL Error - Pot. Mode (P-INL) vs. Wiper Setting and Temperature (10.0 kΩ, 8-bit: $V_L = 1.8\text{V}$, 2.7V, 5.5V, $A = V^+$, $B = V^-$, $\text{DGND} = V^-$, $V^+ = 20\text{V}$).

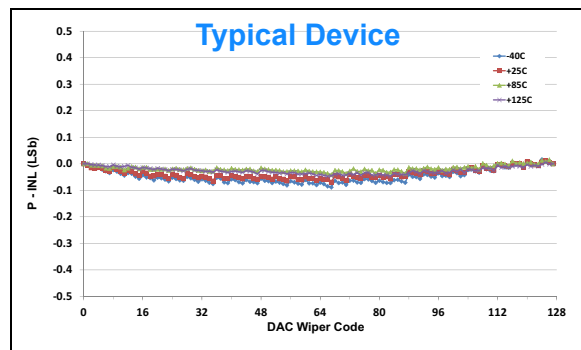

FIGURE 1-88: INL Error - Pot. Mode (P-INL) vs. Wiper Setting and Temperature (10.0 kΩ, 7-bit: $V_L = 1.8\text{V}$, 2.7V, 5.5V, $A = V^+$, $B = V^-$, $\text{DGND} = V^-$, $V^+ = 20\text{V}$).

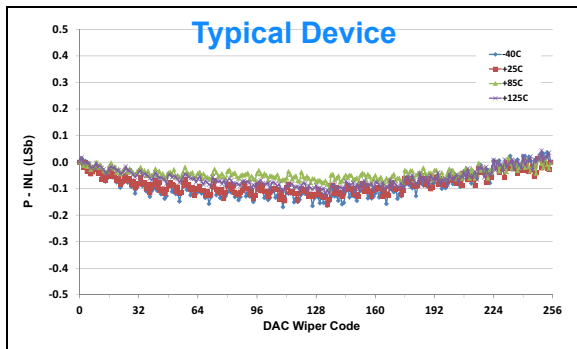

FIGURE 1-86: INL Error - Pot. Mode (P-INL) vs. Wiper Setting and Temperature (10.0 kΩ, 8-bit: $V_L = 1.8\text{V}$, 2.7V, 5.5V, $A = V^+$, $B = V^-$, $\text{DGND} = V^-$, $V^+ = 10\text{V}$).

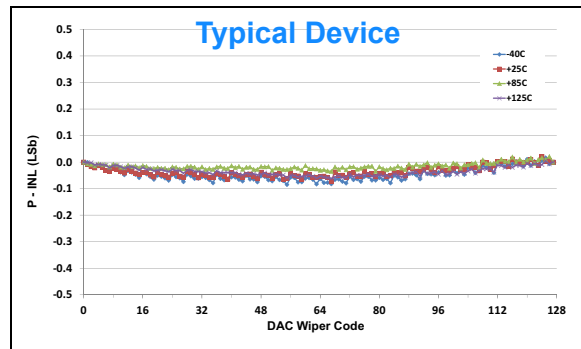

FIGURE 1-89: INL Error - Pot. Mode (P-INL) vs. Wiper Setting and Temperature (10.0 kΩ, 7-bit: $V_L = 1.8\text{V}$, 2.7V, 5.5V, $A = V^+$, $B = V^-$, $\text{DGND} = V^-$, $V^+ = 10\text{V}$).

Note: Unless otherwise indicated, $T_A = +25^\circ\text{C}$, $V_L = 5.0\text{V}$, $\text{DGND} = V_-$, $V_+ = 36\text{V}$.

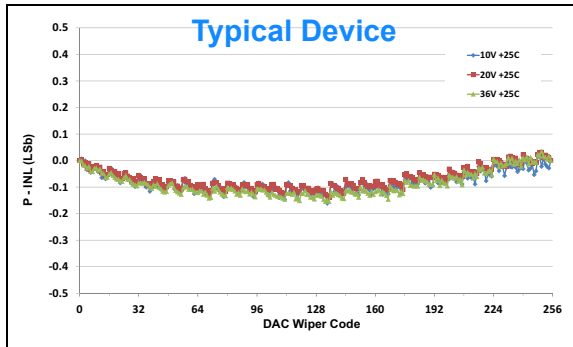

FIGURE 1-90: INL Error - Pot. Mode (P-INL) vs. Wiper Setting (@ 25°C)
 (10.0 k Ω , 8-bit: $V_L = 1.8\text{V}, 2.7\text{V}, 5.5\text{V}$,
 $A = V_+, B = V_-, \text{DGND} = V_-, V_+ = 36\text{V}, 20\text{V}, 10\text{V}$).

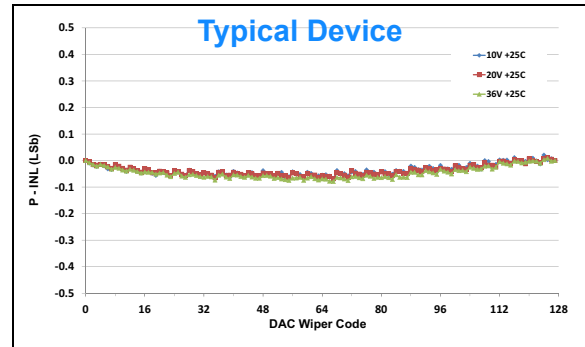

FIGURE 1-91: INL Error - Pot. Mode (P-INL) vs. Wiper Setting (@ 25°C)
 (10.0 k Ω , 7-bit: $V_L = 1.8\text{V}, 2.7\text{V}, 5.5\text{V}$,
 $A = V_+, B = V_-, \text{DGND} = V_-, V_+ = 36\text{V}, 20\text{V}, 10\text{V}$).

MCP41HVX1

Note: Unless otherwise indicated, $T_A = +25^\circ\text{C}$, $V_L = 5.0\text{V}$, $\text{DGND} = V^-$, $V^+ = 36\text{V}$.

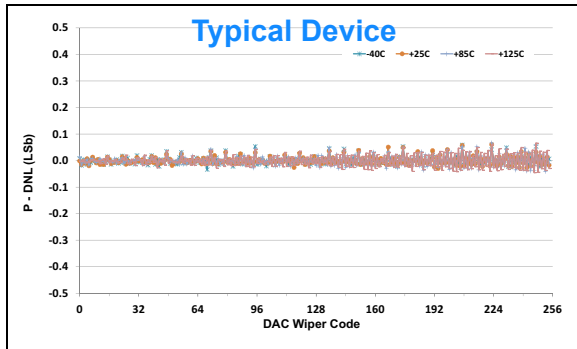

FIGURE 1-92: DNL Error - Pot. Mode (P-DNL) vs. Wiper Setting and Temperature (10.0 kΩ, 8-bit: $V_L = 1.8\text{V}$, 2.7V, 5.5V, $A = V^+$, $B = V^-$, $\text{DGND} = V^-$, $V^+ = 36\text{V}$).

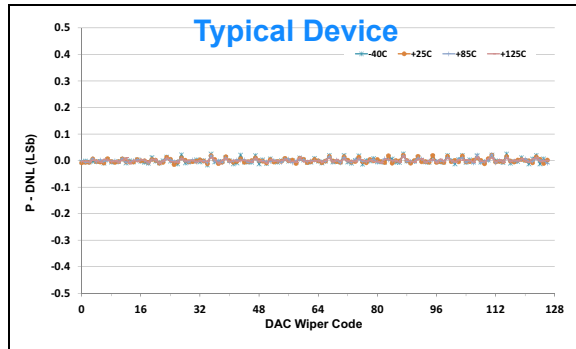

FIGURE 1-95: DNL Error - Pot. Mode (P-DNL) vs. Wiper Setting and Temperature (10.0 kΩ, 7-bit: $V_L = 1.8\text{V}$, 2.7V, 5.5V, $A = V^+$, $B = V^-$, $\text{DGND} = V^-$, $V^+ = 36\text{V}$).

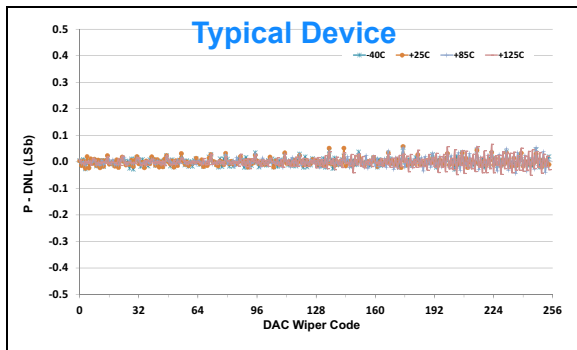

FIGURE 1-93: DNL Error - Pot. Mode (P-DNL) vs. Wiper Setting and Temperature (10.0 kΩ, 8-bit: $V_L = 1.8\text{V}$, 2.7V, 5.5V, $A = V^+$, $B = V^-$, $\text{DGND} = V^-$, $V^+ = 20\text{V}$).

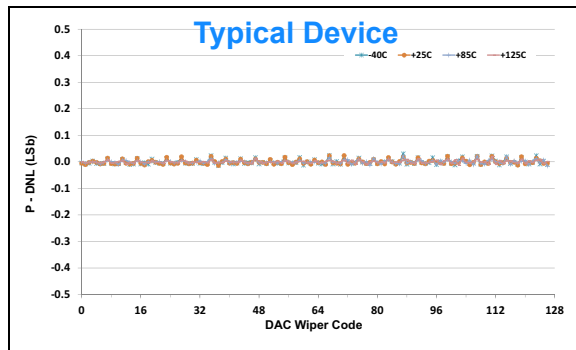

FIGURE 1-96: DNL Error - Pot. Mode (P-DNL) vs. Wiper Setting and Temperature (10.0 kΩ, 7-bit: $V_L = 1.8\text{V}$, 2.7V, 5.5V, $A = V^+$, $B = V^-$, $\text{DGND} = V^-$, $V^+ = 20\text{V}$).

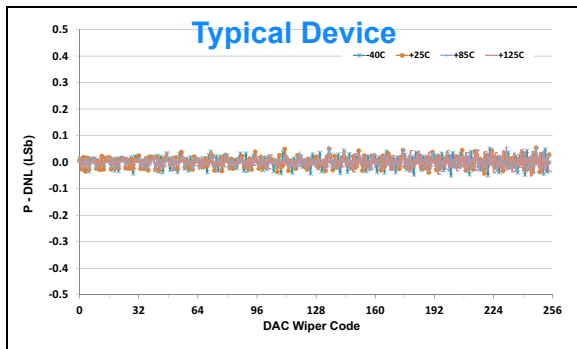

FIGURE 1-94: DNL Error - Pot. Mode (P-DNL) vs. Wiper Setting and Temperature (10.0 kΩ, 8-bit: $V_L = 1.8\text{V}$, 2.7V, 5.5V, $A = V^+$, $B = V^-$, $\text{DGND} = V^-$, $V^+ = 10\text{V}$).

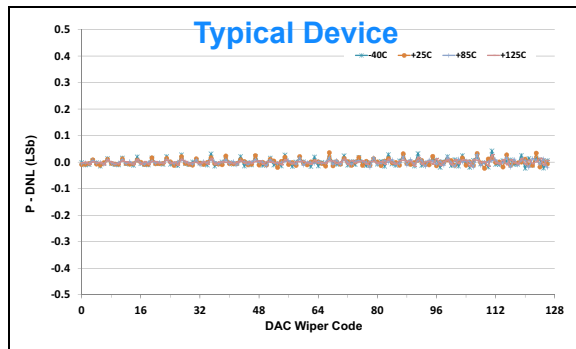

FIGURE 1-97: DNL Error - Pot. Mode (P-DNL) vs. Wiper Setting and Temperature (10.0 kΩ, 7-bit: $V_L = 1.8\text{V}$, 2.7V, 5.5V, $A = V^+$, $B = V^-$, $\text{DGND} = V^-$, $V^+ = 10\text{V}$).

Note: Unless otherwise indicated, $T_A = +25^\circ\text{C}$, $V_L = 5.0\text{V}$, $\text{DGND} = V_-$, $V_+ = 36\text{V}$.

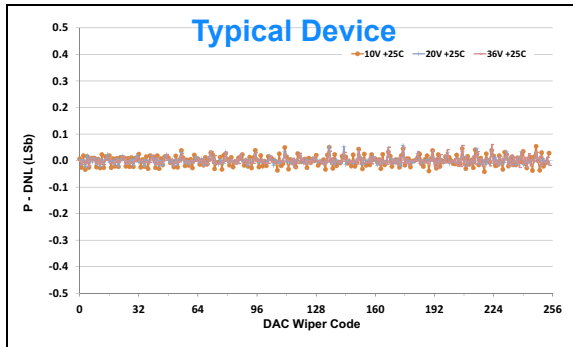

FIGURE 1-98: DNL Error - Pot. Mode (P-DNL) vs. Wiper Setting (@ 25°C) (10.0 kΩ, 8-bit: $V_L = 1.8\text{V}, 2.7\text{V}, 5.5\text{V}$, $A = V_+$, $B = V_-$, $\text{DGND} = V_-$, $V_+ = 36\text{V}, 20\text{V}, 10\text{V}$).

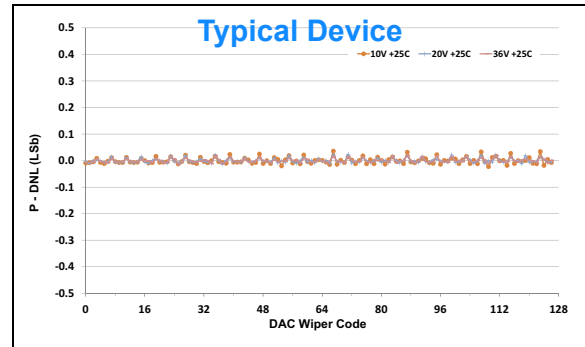

FIGURE 1-99: DNL Error - Pot. Mode (P-DNL) vs. Wiper Setting (@ 25°C) (10.0 kΩ, 7-bit: $V_L = 1.8\text{V}, 2.7\text{V}, 5.5\text{V}$, $A = V_+$, $B = V_-$, $\text{DGND} = V_-$, $V_+ = 36\text{V}, 20\text{V}, 10\text{V}$).

MCP41HVX1

Note: Unless otherwise indicated, $T_A = +25^\circ\text{C}$, $V_L = 5.0\text{V}$, $\text{DGND} = V^-$, $V^+ = 36\text{V}$.

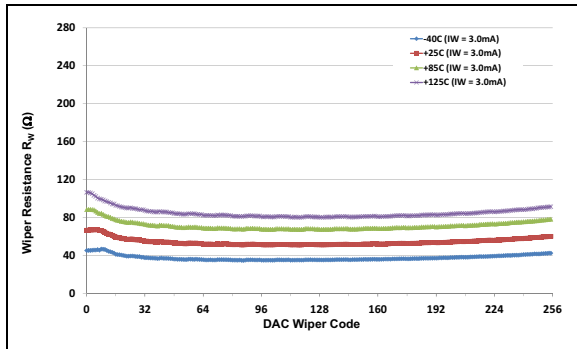

FIGURE 1-100: Wiper Resistance (R_W) vs. Wiper Setting and Temperature (10.0 kΩ, 8-bit: $V_L = 1.8\text{V}$, 2.7V, 5.5V, $A = V^+$, $B = V^-$, $\text{DGND} = V^-$, $V^+ = 36\text{V}$, $I_W = 3.0\text{mA}$).

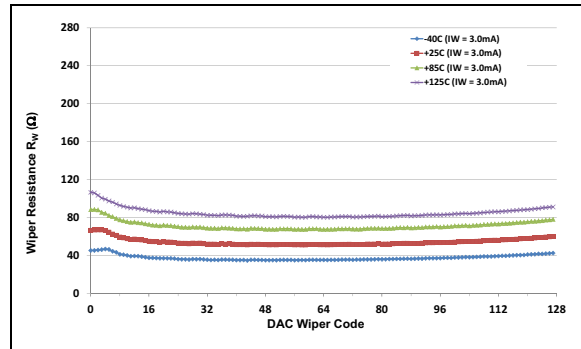

FIGURE 1-103: Wiper Resistance (R_W) vs. Wiper Setting and Temperature (10.0 kΩ, 7-bit: $V_L = 1.8\text{V}$, 2.7V, 5.5V, $A = V^+$, $B = V^-$, $\text{DGND} = V^-$, $V^+ = 36\text{V}$, $I_W = 3.0\text{mA}$).

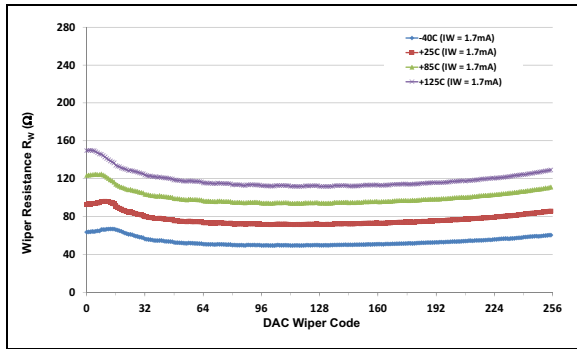

FIGURE 1-101: Wiper Resistance (R_W) vs. Wiper Setting and Temperature (10.0 kΩ, 8-bit: $V_L = 1.8\text{V}$, 2.7V, 5.5V, $A = V^+$, $B = V^-$, $\text{DGND} = V^-$, $V^+ = 20\text{V}$, $I_W = 1.7\text{mA}$).

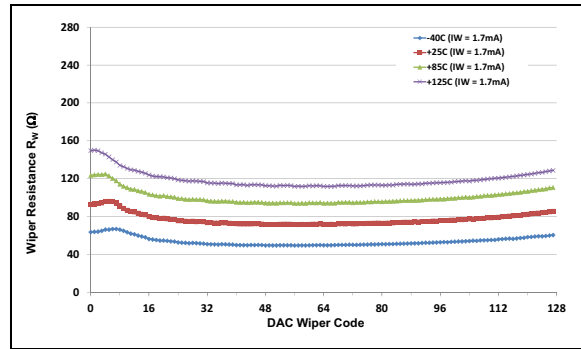

FIGURE 1-104: Wiper Resistance (R_W) vs. Wiper Setting and Temperature (10.0 kΩ, 7-bit: $V_L = 1.8\text{V}$, 2.7V, 5.5V, $A = V^+$, $B = V^-$, $\text{DGND} = V^-$, $V^+ = 20\text{V}$, $I_W = 1.7\text{mA}$).

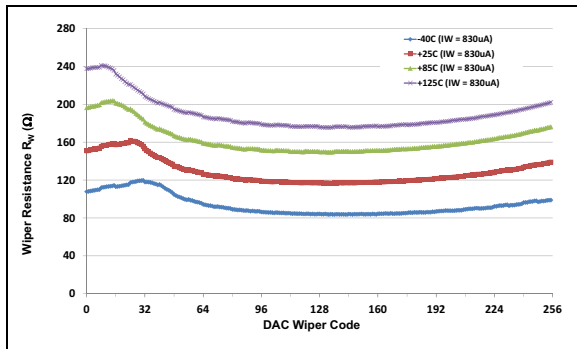

FIGURE 1-102: Wiper Resistance (R_W) vs. Wiper Setting and Temperature (10.0 kΩ, 8-bit: $V_L = 1.8\text{V}$, 2.7V, 5.5V, $A = V^+$, $B = V^-$, $\text{DGND} = V^-$, $V^+ = 10\text{V}$, $I_W = 830\mu\text{A}$).

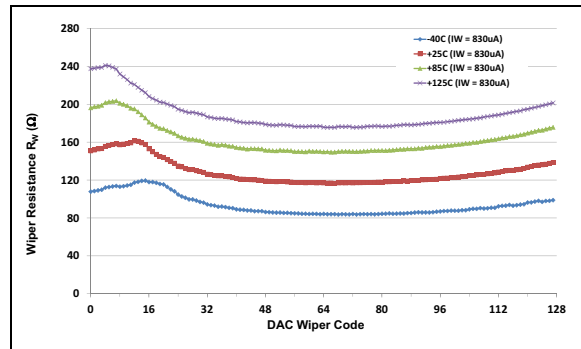

FIGURE 1-105: Wiper Resistance (R_W) vs. Wiper Setting and Temperature (10.0 kΩ, 7-bit: $V_L = 1.8\text{V}$, 2.7V, 5.5V, $A = V^+$, $B = V^-$, $\text{DGND} = V^-$, $V^+ = 10\text{V}$, $I_W = 830\mu\text{A}$).

Note: Unless otherwise indicated, $T_A = +25^\circ\text{C}$, $V_L = 5.0\text{V}$, $\text{DGND} = V_-$, $V_+ = 36\text{V}$.

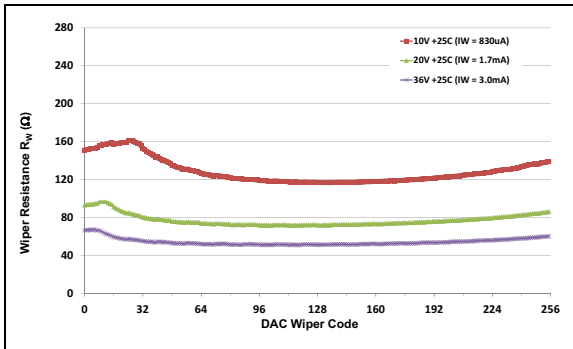

FIGURE 1-106: Wiper Resistance (R_W) vs. Wiper Setting @ 29°C
 (10.0 kΩ, 8-bit: $V_L = 1.8\text{V}$, 2.7V, 5.5V, $A = V_+$, $B = V_-$, $\text{DGND} = V_-$, $V_+ = 36\text{V}$ and $I_W = 3.0\text{mA}$, $V_+ = 20\text{V}$ and $I_W = 1.7\text{mA}$, $V_+ = 10\text{V}$ and $I_W = 830\mu\text{A}$).

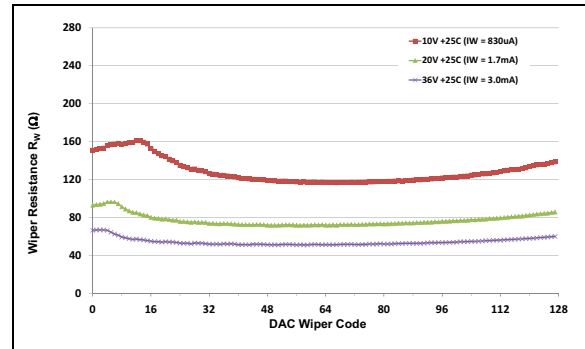

FIGURE 1-107: Wiper Resistance (R_W) vs. Wiper Setting @ 29°C
 (10.0 kΩ, 7-bit: $V_L = 1.8\text{V}$, 2.7V, 5.5V, $A = V_+$, $B = V_-$, $\text{DGND} = V_-$, $V_+ = 36\text{V}$ and $I_W = 3.0\text{mA}$, $V_+ = 20\text{V}$ and $I_W = 1.7\text{mA}$, $V_+ = 10\text{V}$ and $I_W = 830\mu\text{A}$).

MCP41HVX1

Note: Unless otherwise indicated, $T_A = +25^\circ\text{C}$, $V_L = 5.0\text{V}$, $\text{DGND} = V^-$, $V^+ = 36\text{V}$.

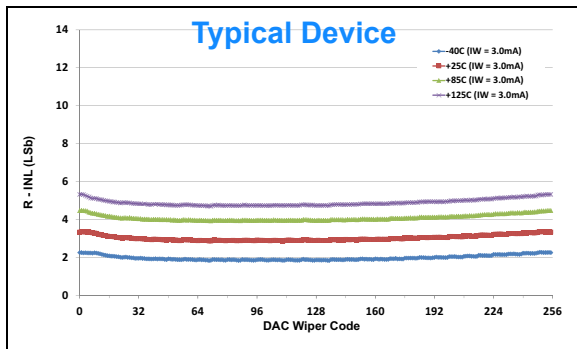

FIGURE 1-108: INL Error - Rheo. Mode (R-INL) vs. Wiper Setting and Temperature (10.0 kΩ, 8-bit: $V_L = 1.8\text{V}, 2.7\text{V}, 5.5\text{V}$, $A = V^+$, $B = V^-$, $\text{DGND} = V^-$, $V^+ = 36\text{V}$, $I_W = 3.0\text{mA}$).

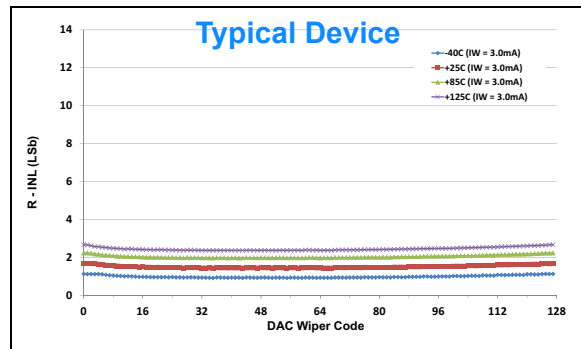

FIGURE 1-111: INL Error - Rheo. Mode (R-INL) vs. Wiper Setting and Temperature (10.0 kΩ, 7-bit: $V_L = 1.8\text{V}, 2.7\text{V}, 5.5\text{V}$, $A = V^+$, $B = V^-$, $\text{DGND} = V^-$, $V^+ = 36\text{V}$, $I_W = 3.0\text{mA}$).

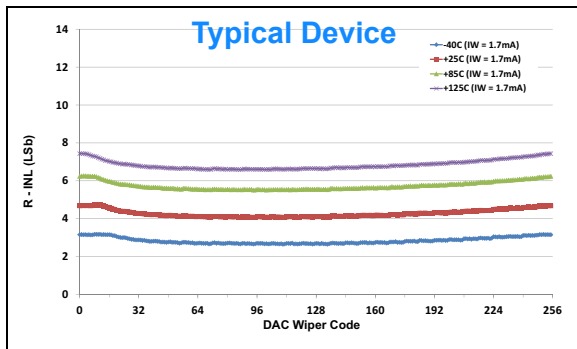

FIGURE 1-109: INL Error - Rheo. Mode (R-INL) vs. Wiper Setting and Temperature (10.0 kΩ, 8-bit: $V_L = 1.8\text{V}, 2.7\text{V}, 5.5\text{V}$, $A = V^+$, $B = V^-$, $\text{DGND} = V^-$, $V^+ = 20\text{V}$, $I_W = 1.7\text{mA}$).

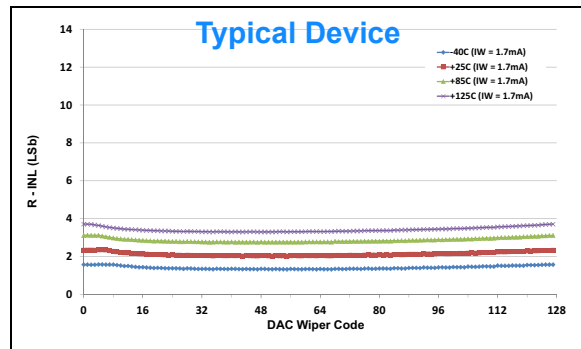

FIGURE 1-112: INL Error - Rheo. Mode (R-INL) vs. Wiper Setting and Temperature (10.0 kΩ, 7-bit: $V_L = 1.8\text{V}, 2.7\text{V}, 5.5\text{V}$, $A = V^+$, $B = V^-$, $\text{DGND} = V^-$, $V^+ = 20\text{V}$, $I_W = 1.7\text{mA}$).

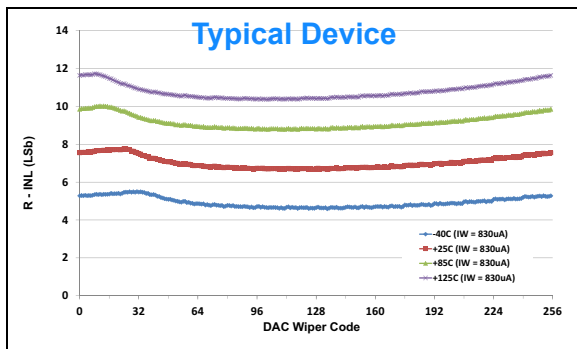

FIGURE 1-110: INL Error - Rheo. Mode (R-INL) vs. Wiper Setting and Temperature (10.0 kΩ, 8-bit: $V_L = 1.8\text{V}, 2.7\text{V}, 5.5\text{V}$, $A = V^+$, $B = V^-$, $\text{DGND} = V^-$, $V^+ = 10\text{V}$, $I_W = 830\mu\text{A}$).

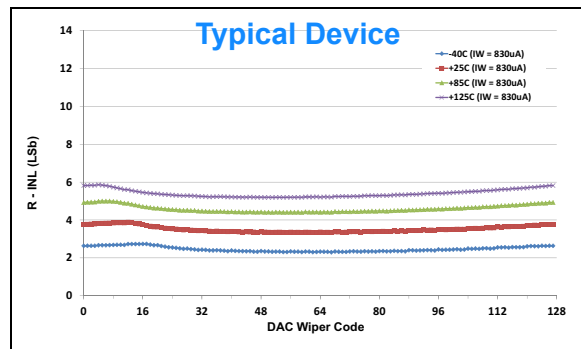

FIGURE 1-113: INL Error - Rheo. Mode (R-INL) vs. Wiper Setting and Temperature (10.0 kΩ, 7-bit: $V_L = 1.8\text{V}, 2.7\text{V}, 5.5\text{V}$, $A = V^+$, $B = V^-$, $\text{DGND} = V^-$, $V^+ = 10\text{V}$, $I_W = 830\mu\text{A}$).

Note: Unless otherwise indicated, $T_A = +25^\circ\text{C}$, $V_L = 5.0\text{V}$, $\text{DGND} = V_-$, $V_+ = 36\text{V}$

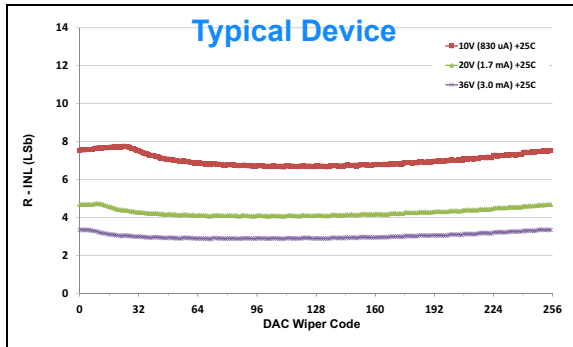

FIGURE 1-114: INL Error - Rheo. Mode (R-INL) vs. Wiper Setting (@ 25°C)
 (10.0 k Ω , 8-bit: $V_L = 1.8\text{V}$, 2.7V, 5.5V,
 $A = V_+$, $B = V_-$, $\text{DGND} = V_-$,
 $V_+ = 36\text{V}$ and $I_W = 3.0\text{ mA}$, $V_+ = 20\text{V}$ and
 $I_W = 1.7\text{ mA}$, $V_+ = 10\text{V}$ and $I_W = 830\text{ }\mu\text{A}$).

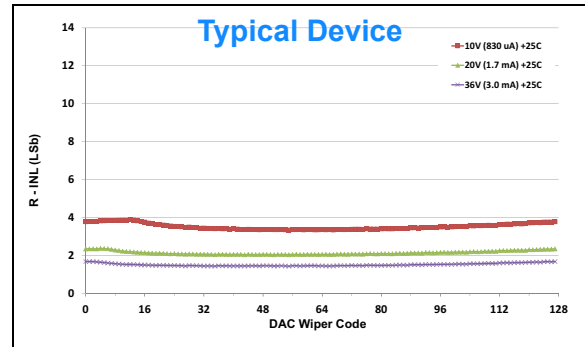

FIGURE 1-115: INL Error - Rheo. Mode (R-INL) vs. Wiper Setting (@ 25°C)
 (10.0 k Ω , 7-bit: $V_L = 1.8\text{V}$, 2.7V, 5.5V,
 $A = V_+$, $B = V_-$, $\text{DGND} = V_-$,
 $V_+ = 36\text{V}$ and $I_W = 3.0\text{ mA}$, $V_+ = 20\text{V}$ and
 $I_W = 1.7\text{ mA}$, $V_+ = 10\text{V}$ and $I_W = 830\text{ }\mu\text{A}$).

MCP41HVX1

Note: Unless otherwise indicated, $T_A = +25^\circ\text{C}$, $V_L = 5.0\text{V}$, $\text{DGND} = \text{V-}$, $\text{V+} = 36\text{V}$.

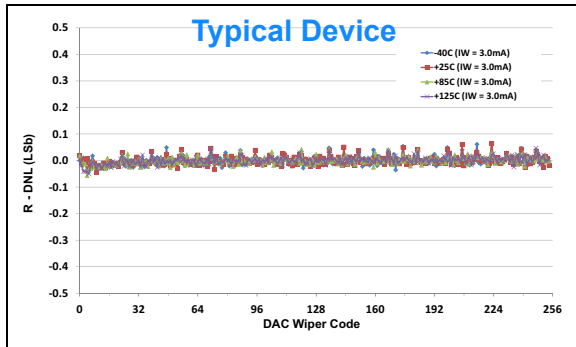

FIGURE 1-116: DNL Error - Rheo. Mode (R-DNL) vs. Wiper Setting and Temperature (10.0 k Ω , 8-bit: $V_L = 1.8\text{V}$, 2.7V, 5.5V, $A = \text{V+}$, $B = \text{V-}$, $\text{DGND} = \text{V-}$, $\text{V+} = 36\text{V}$, $I_W = 3.0\text{mA}$).

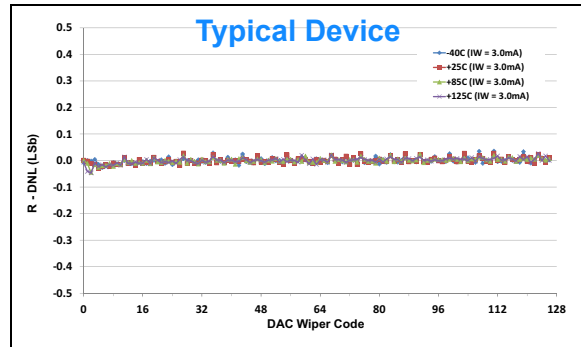

FIGURE 1-119: DNL Error - Rheo. Mode (R-DNL) vs. Wiper Setting and Temperature (10.0 k Ω , 7-bit: $V_L = 1.8\text{V}$, 2.7V, 5.5V, $A = \text{V+}$, $B = \text{V-}$, $\text{DGND} = \text{V-}$, $\text{V+} = 36\text{V}$, $I_W = 3.0\text{mA}$).

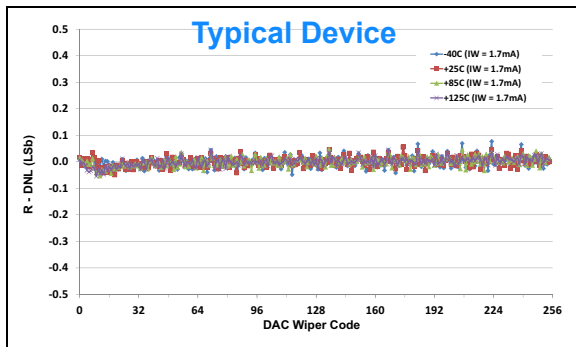

FIGURE 1-117: DNL Error - Rheo. Mode (R-DNL) vs. Wiper Setting and Temperature (10.0 k Ω , 8-bit: $V_L = 1.8\text{V}$, 2.7V, 5.5V, $A = \text{V+}$, $B = \text{V-}$, $\text{DGND} = \text{V-}$, $\text{V+} = 20\text{V}$, $I_W = 1.7\text{mA}$).

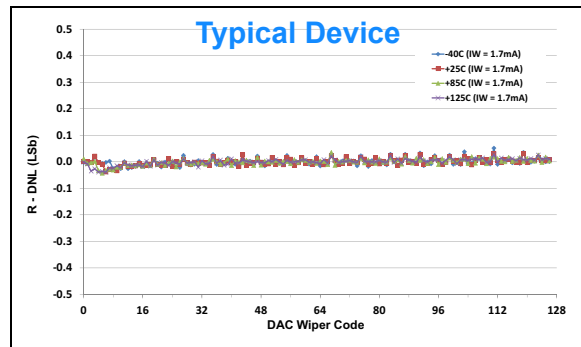

FIGURE 1-120: DNL Error - Rheo. Mode (R-DNL) vs. Wiper Setting and Temperature (10.0 k Ω , 7-bit: $V_L = 1.8\text{V}$, 2.7V, 5.5V, $A = \text{V+}$, $B = \text{V-}$, $\text{DGND} = \text{V-}$, $\text{V+} = 20\text{V}$, $I_W = 1.7\text{mA}$).

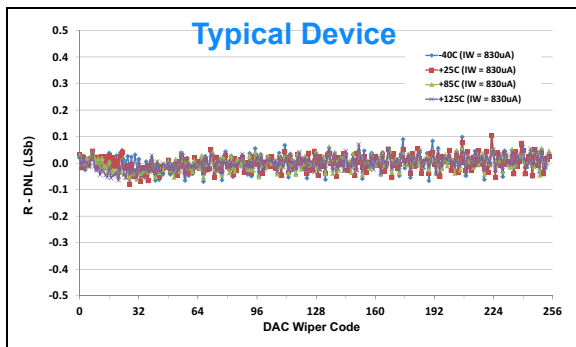

FIGURE 1-118: DNL Error - Rheo. Mode (R-DNL) vs. Wiper Setting and Temperature (10.0 k Ω , 8-bit: $V_L = 1.8\text{V}$, 2.7V, 5.5V, $A = \text{V+}$, $B = \text{V-}$, $\text{DGND} = \text{V-}$, $\text{V+} = 10\text{V}$, $I_W = 830\mu\text{A}$).

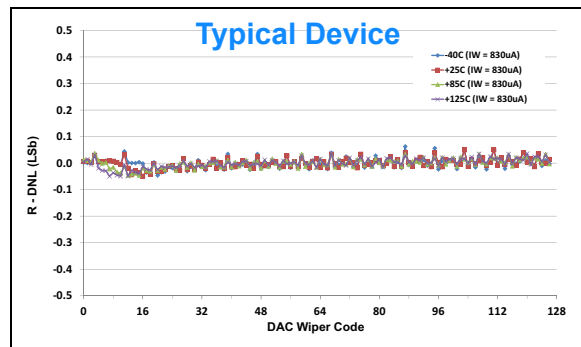

FIGURE 1-121: DNL Error - Rheo. Mode (R-DNL) vs. Wiper Setting and Temperature (10.0 k Ω , 7-bit: $V_L = 1.8\text{V}$, 2.7V, 5.5V, $A = \text{V+}$, $B = \text{V-}$, $\text{DGND} = \text{V-}$, $\text{V+} = 10\text{V}$, $I_W = 830\mu\text{A}$).

Note: Unless otherwise indicated, $T_A = +25^\circ\text{C}$, $V_L = 5.0\text{V}$, $\text{DGND} = V_-$, $V_+ = 36\text{V}$.

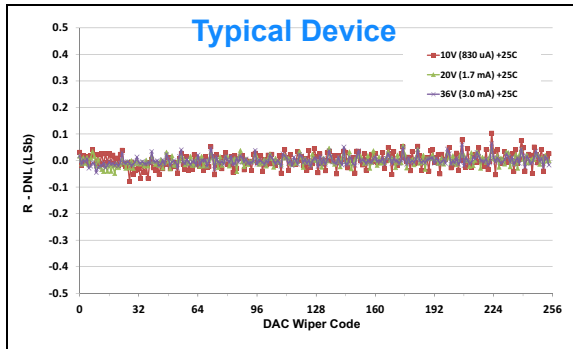

FIGURE 1-122: DNL Error - Rheo. Mode (R-DNL) vs. Wiper Setting (@ 25°C)
 (10.0 k Ω , 8-bit: $V_L = 1.8\text{V}$, 2.7V, 5.5V, $A = V_+$, $B = V_-$, $\text{DGND} = V_-$,
 $V_+ = 36\text{V}$ and $I_W = 3.0\text{ mA}$, $V_+ = 20\text{V}$ and $I_W = 1.7\text{ mA}$, $V_+ = 10\text{V}$ and $I_W = 830\text{ }\mu\text{A}$).

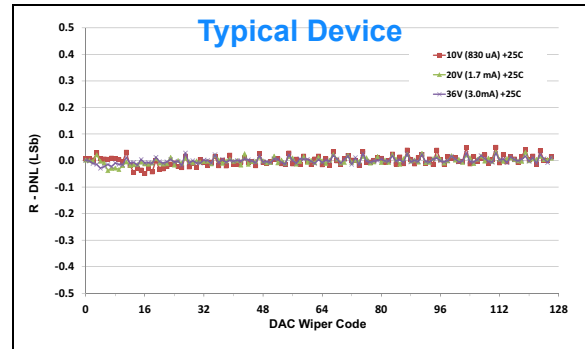

FIGURE 1-123: DNL Error - Rheo. Mode (R-DNL) vs. Wiper Setting (@ 25°C)
 (10.0 k Ω , 7-bit: $V_L = 1.8\text{V}$, 2.7V, 5.5V, $A = V_+$, $B = V_-$, $\text{DGND} = V_-$,
 $V_+ = 36\text{V}$ and $I_W = 3.0\text{ mA}$, $V_+ = 20\text{V}$ and $I_W = 1.7\text{ mA}$, $V_+ = 10\text{V}$ and $I_W = 830\text{ }\mu\text{A}$).

MCP41HVX1

Note: Unless otherwise indicated, $T_A = +25^\circ\text{C}$, $V_L = 5.0\text{V}$, $\text{DGND} = \text{V-}$, $\text{V+} = 36\text{V}$.

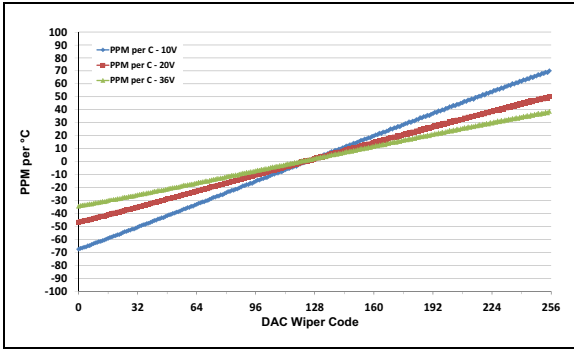

FIGURE 1-124: $V_W \text{ PPM}/^\circ\text{C}$ (Pot. Mode) vs. Temperature, and $V+$ Voltage

$$\left(\left(V_{W(\text{code}=n, 125^\circ\text{C})} - V_{W(\text{code}=n, -40^\circ\text{C})} \right) / V_{W(\text{code}=255, 25^\circ\text{C})} \right) * 1,000,000 / 165^\circ\text{C}$$

(10.0 k Ω , 8-bit: $V_L = 1.8\text{V}, 2.7\text{V}, 5.5\text{V}$,
 $A = \text{V+}$, $B = \text{V-}$, $\text{DGND} = \text{V-}$, $\text{V+} = 36\text{V}, 20\text{V}, 10\text{V}$).

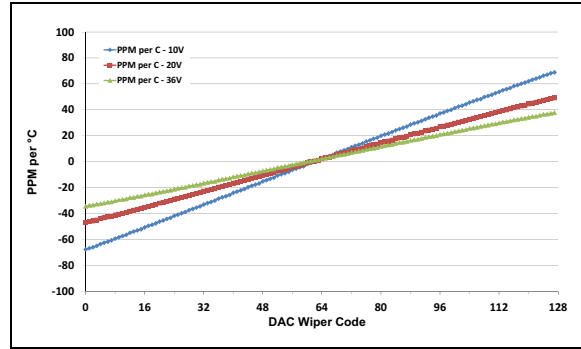

FIGURE 1-125: $V_W \text{ PPM}/^\circ\text{C}$ (Pot. Mode) vs. Temperature, and $V+$ Voltage

$$\left(\left(V_{W(\text{code}=n, 125^\circ\text{C})} - V_{W(\text{code}=n, -40^\circ\text{C})} \right) / V_{W(\text{code}=127, 25^\circ\text{C})} \right) * 1,000,000 / 165^\circ\text{C}$$

(10.0 k Ω , 7-bit: $V_L = 1.8\text{V}, 2.7\text{V}, 5.5\text{V}$,
 $A = \text{V+}$, $B = \text{V-}$, $\text{DGND} = \text{V-}$, $\text{V+} = 36\text{V}, 20\text{V}, 10\text{V}$).

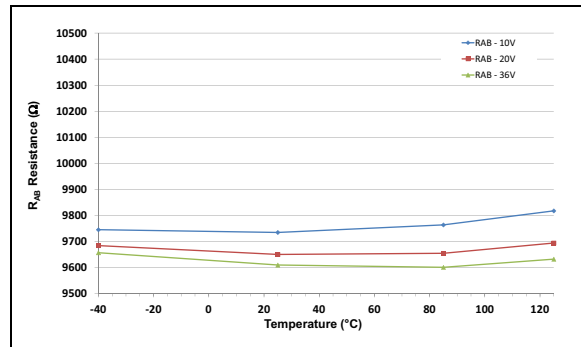

FIGURE 1-126: R_{AB} Resistance vs. Temperature and $V+$ Voltage
 (10.0 k Ω : $V_L = 1.8\text{V}, 2.7\text{V}, 5.5\text{V}$,
 $A = \text{V+}$, $B = \text{V-}$, $\text{DGND} = \text{V-}$, $\text{V+} = 36\text{V}, 20\text{V}, 10\text{V}$).

Note: Unless otherwise indicated, $T_A = +25^\circ\text{C}$, $V_L = 5.0\text{V}$, $\text{DGND} = V^-$, $V^+ = 36\text{V}$.

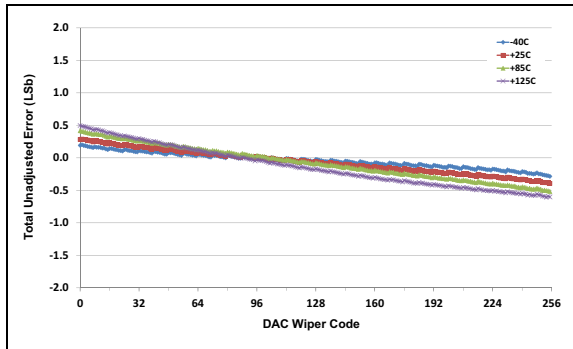

FIGURE 1-127: Total Unadjusted Error (Pot. Mode) (V_W) vs. Wiper Setting and Temperature (50.0 k Ω , 8-bit: $V_L = 1.8\text{V}, 2.7\text{V}, 5.5\text{V}$, $A = V^+$, $B = V^-$, $\text{DGND} = V^-$, $V^+ = 36\text{V}$).

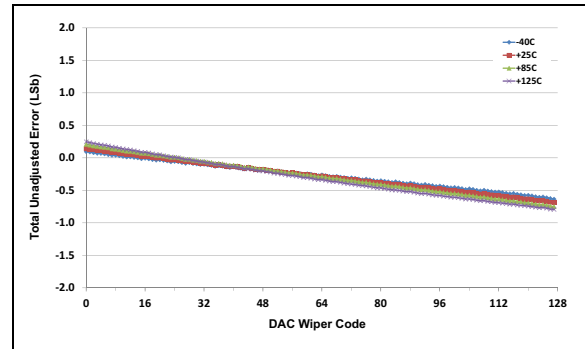

FIGURE 1-130: Total Unadjusted Error (Pot. Mode) (V_W) vs. Wiper Setting and Temperature (50.0 k Ω , 7-bit: $V_L = 1.8\text{V}, 2.7\text{V}, 5.5\text{V}$, $A = V^+$, $B = V^-$, $\text{DGND} = V^-$, $V^+ = 36\text{V}$).

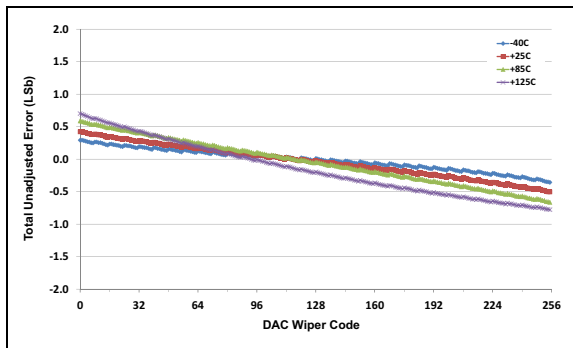

FIGURE 1-128: Total Unadjusted Error (Pot. Mode) (V_W) vs. Wiper Setting and Temperature (50.0 k Ω , 8-bit: $V_L = 1.8\text{V}, 2.7\text{V}, 5.5\text{V}$, $A = V^+$, $B = V^-$, $\text{DGND} = V^-$, $V^+ = 20\text{V}$).

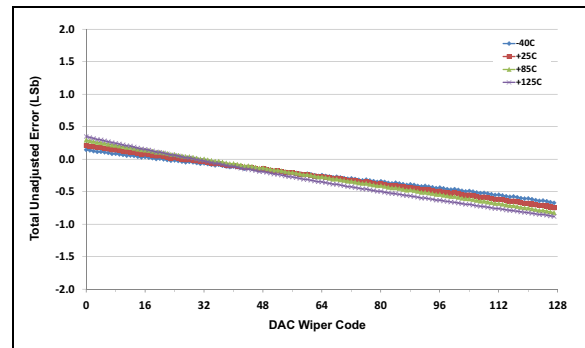

FIGURE 1-131: Total Unadjusted Error (Pot. Mode) (V_W) vs. Wiper Setting and Temperature (50.0 k Ω , 7-bit: $V_L = 1.8\text{V}, 2.7\text{V}, 5.5\text{V}$, $A = V^+$, $B = V^-$, $\text{DGND} = V^-$, $V^+ = 20\text{V}$).

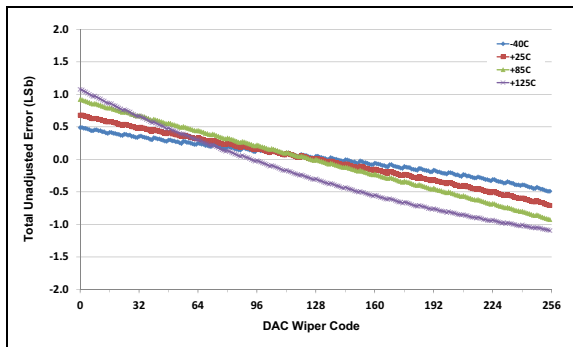

FIGURE 1-129: Total Unadjusted Error (Pot. Mode) (V_W) vs. Wiper Setting and Temperature (50.0 k Ω , 8-bit: $V_L = 1.8\text{V}, 2.7\text{V}, 5.5\text{V}$, $A = V^+$, $B = V^-$, $\text{DGND} = V^-$, $V^+ = 10\text{V}$).

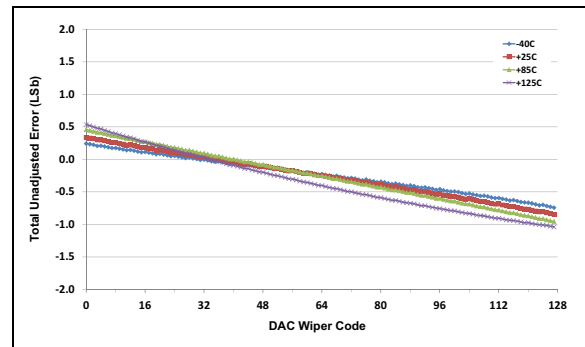

FIGURE 1-132: Total Unadjusted Error (Pot. Mode) (V_W) vs. Wiper Setting and Temperature (50.0 k Ω , 7-bit: $V_L = 1.8\text{V}, 2.7\text{V}, 5.5\text{V}$, $A = V^+$, $B = V^-$, $\text{DGND} = V^-$, $V^+ = 10\text{V}$).

MCP41HVX1

Note: Unless otherwise indicated, $T_A = +25^\circ\text{C}$, $V_L = 5.0\text{V}$, $\text{DGND} = \text{V-}$, $\text{V+} = 36\text{V}$.

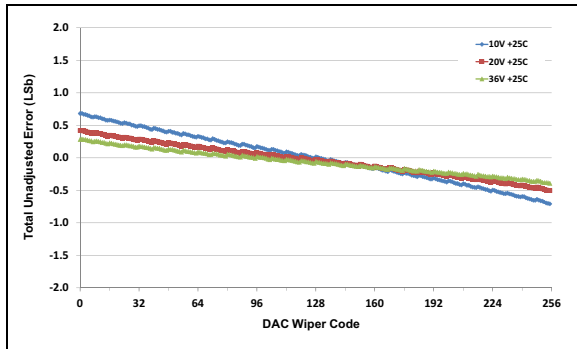

FIGURE 1-133: Total Unadjusted Error (Pot. Mode) (V_W) vs. Wiper Setting (@ 25°C) ($50.0\text{ k}\Omega$, **8-bit**: $V_L = 1.8\text{V}, 2.7\text{V}, 5.5\text{V}$, $A = \text{V+}$, $B = \text{V-}$, $\text{DGND} = \text{V-}$, $\text{V+} = 36\text{V}, 20\text{V}, 10\text{V}$).

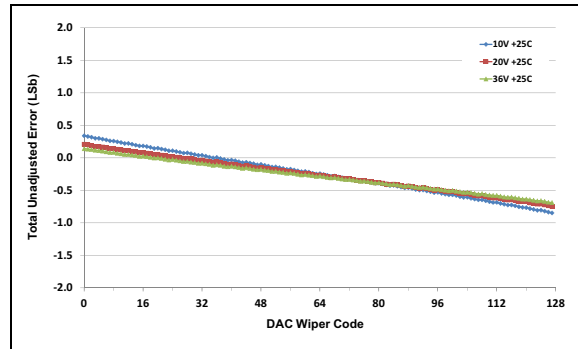

FIGURE 1-136: Total Unadjusted Error (Pot. Mode) (V_W) vs. Wiper Setting (@ 25°C) ($50.0\text{ k}\Omega$, **7-bit**: $V_L = 1.8\text{V}, 2.7\text{V}, 5.5\text{V}$, $A = \text{V+}$, $B = \text{V-}$, $\text{DGND} = \text{V-}$, $\text{V+} = 36\text{V}, 20\text{V}, 10\text{V}$).

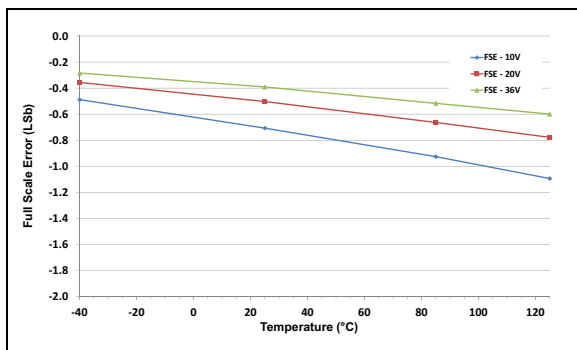

FIGURE 1-134: Full Scale Error (Pot. Mode) (FSE) vs. Temperature and $V+$ Voltage ($50.0\text{ k}\Omega$, **8-bit**: $V_L = 1.8\text{V}, 2.7\text{V}, 5.5\text{V}$, $A = \text{V+}$, $B = \text{V-}$, $\text{DGND} = \text{V-}$, $\text{V+} = 36\text{V}, 20\text{V}, 10\text{V}$).

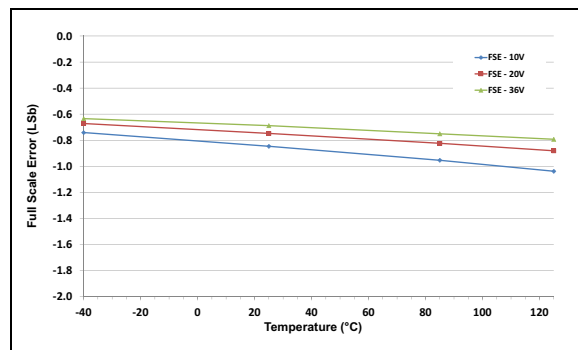

FIGURE 1-137: Full Scale Error (Pot. Mode) (FSE) vs. Temperature and $V+$ Voltage ($50.0\text{ k}\Omega$, **7-bit**: $V_L = 1.8\text{V}, 2.7\text{V}, 5.5\text{V}$, $A = \text{V+}$, $B = \text{V-}$, $\text{DGND} = \text{V-}$, $\text{V+} = 36\text{V}, 20\text{V}, 10\text{V}$).

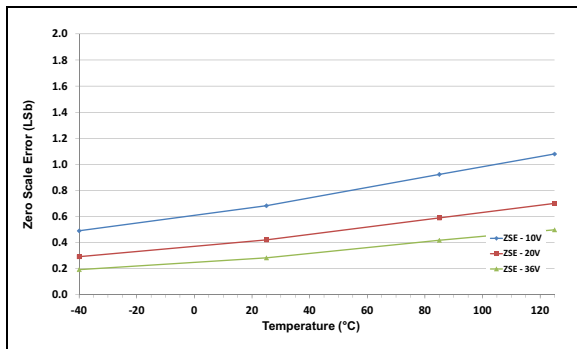

FIGURE 1-135: Zero Scale Error (Pot. Mode) (ZSE) vs. Temperature and $V+$ Voltage ($50.0\text{ k}\Omega$, **8-bit**: $V_L = 1.8\text{V}, 2.7\text{V}, 5.5\text{V}$, $A = \text{V+}$, $B = \text{V-}$, $\text{DGND} = \text{V-}$, $\text{V+} = 36\text{V}, 20\text{V}, 10\text{V}$).

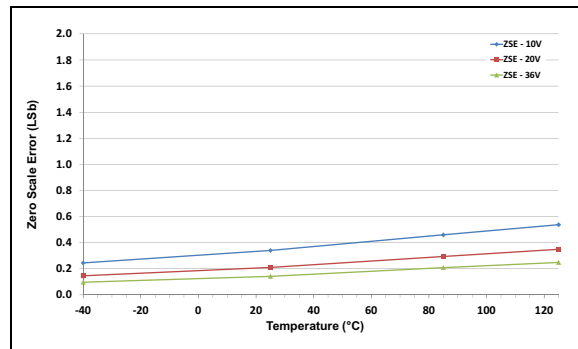

FIGURE 1-138: Zero Scale Error (Pot. Mode) (ZSE) vs. Temperature and $V+$ Voltage ($50.0\text{ k}\Omega$, **7-bit**: $V_L = 1.8\text{V}, 2.7\text{V}, 5.5\text{V}$, $A = \text{V+}$, $B = \text{V-}$, $\text{DGND} = \text{V-}$, $\text{V+} = 36\text{V}, 20\text{V}, 10\text{V}$).

Note: Unless otherwise indicated, $T_A = +25^\circ\text{C}$, $V_L = 5.0\text{V}$, $\text{DGND} = V_-$, $V_+ = 36\text{V}$.

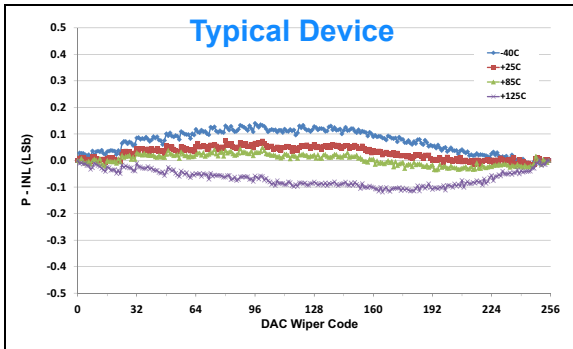

FIGURE 1-139: INL Error - Pot. Mode (P-INL) vs. Wiper Setting and Temperature (50.0 kΩ, 8-bit: $V_L = 1.8\text{V}, 2.7\text{V}, 5.5\text{V}$, $A = V_+$, $B = V_-$, $\text{DGND} = V_-$, $V_+ = 36\text{V}$).

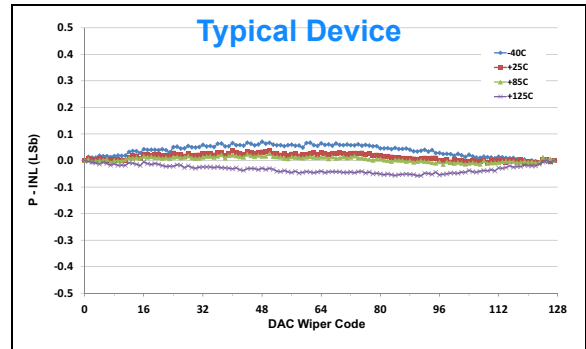

FIGURE 1-142: INL Error - Pot. Mode (P-INL) vs. Wiper Setting and Temperature (50.0 kΩ, 7-bit: $V_L = 1.8\text{V}, 2.7\text{V}, 5.5\text{V}$, $A = V_+$, $B = V_-$, $\text{DGND} = V_-$, $V_+ = 36\text{V}$).

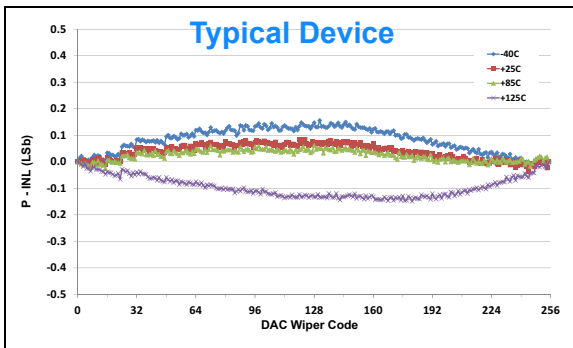

FIGURE 1-140: INL Error - Pot. Mode (P-INL) vs. Wiper Setting and Temperature (50.0 kΩ, 8-bit: $V_L = 1.8\text{V}, 2.7\text{V}, 5.5\text{V}$, $A = V_+$, $B = V_-$, $\text{DGND} = V_-$, $V_+ = 20\text{V}$).

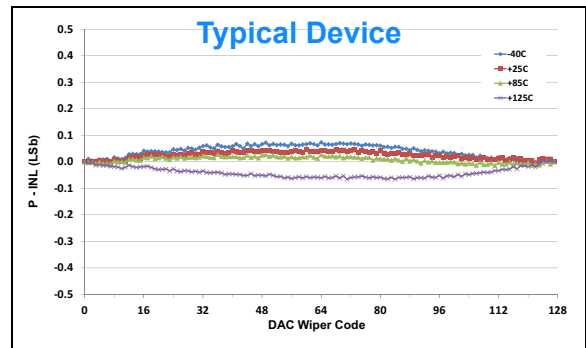

FIGURE 1-143: INL Error - Pot. Mode (P-INL) vs. Wiper Setting and Temperature (50.0 kΩ, 7-bit: $V_L = 1.8\text{V}, 2.7\text{V}, 5.5\text{V}$, $A = V_+$, $B = V_-$, $\text{DGND} = V_-$, $V_+ = 20\text{V}$).

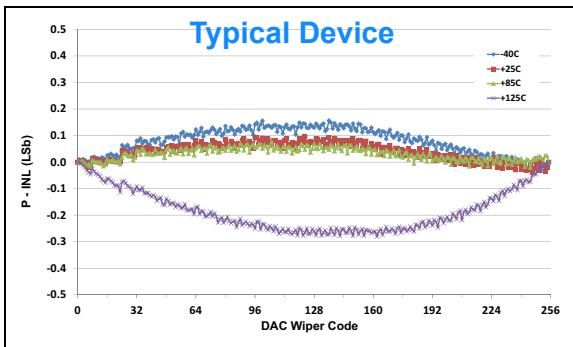

FIGURE 1-141: INL Error - Pot. Mode (P-INL) vs. Wiper Setting and Temperature (50.0 kΩ, 8-bit: $V_L = 1.8\text{V}, 2.7\text{V}, 5.5\text{V}$, $A = V_+$, $B = V_-$, $\text{DGND} = V_-$, $V_+ = 10\text{V}$).

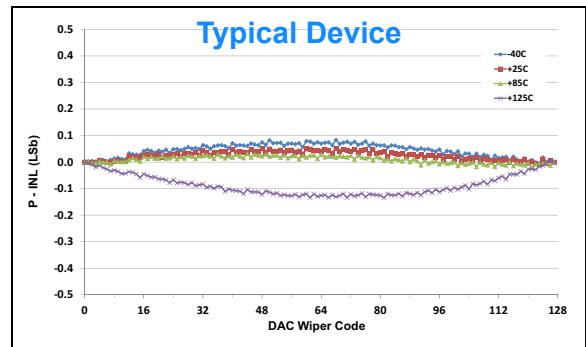

FIGURE 1-144: INL Error - Pot. Mode (P-INL) vs. Wiper Setting and Temperature (50.0 kΩ, 7-bit: $V_L = 1.8\text{V}, 2.7\text{V}, 5.5\text{V}$, $A = V_+$, $B = V_-$, $\text{DGND} = V_-$, $V_+ = 10\text{V}$).

MCP41HVX1

Note: Unless otherwise indicated, $T_A = +25^\circ\text{C}$, $V_L = 5.0\text{V}$, $\text{DGND} = V^-$, $V^+ = 36\text{V}$.

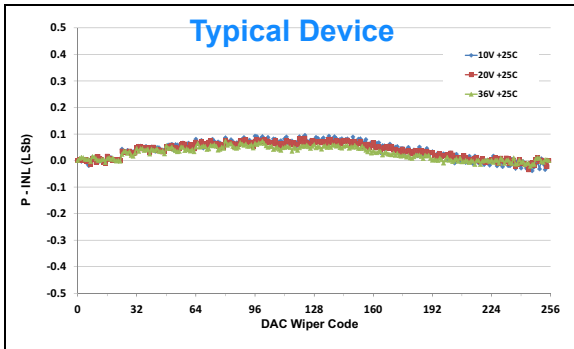

FIGURE 1-145: INL Error - Pot. Mode (P-INL) vs. Wiper Setting (@ 25°C)
($50.0\text{ k}\Omega$, **8-bit**: $V_L = 1.8\text{V}$, 2.7V , 5.5V , $A = V^+$, $B = V^-$, $\text{DGND} = V^-$, $V^+ = 36\text{V}$, 20V , 10V).

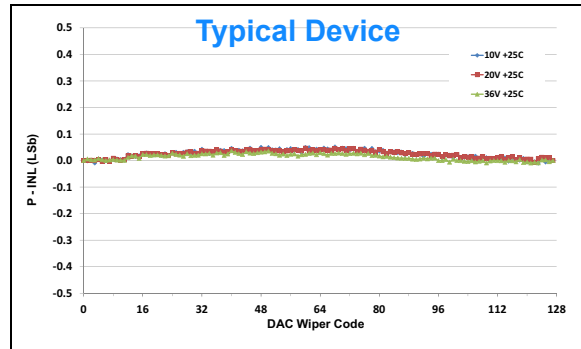

FIGURE 1-146: INL Error - Pot. Mode (P-INL) vs. Wiper Setting (@ 25°C)
($50.0\text{ k}\Omega$, **7-bit**: $V_L = 1.8\text{V}$, 2.7V , 5.5V , $A = V^+$, $B = V^-$, $\text{DGND} = V^-$, $V^+ = 36\text{V}$, 20V , 10V).

Note: Unless otherwise indicated, $T_A = +25^\circ\text{C}$, $V_L = 5.0\text{V}$, $\text{DGND} = V_-$, $V_+ = 36\text{V}$.

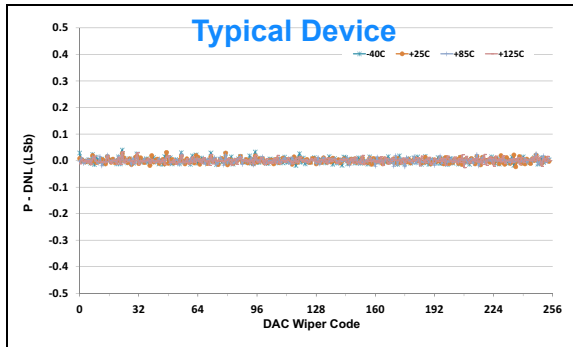

FIGURE 1-147: DNL Error - Pot. Mode (P-DNL) vs. Wiper Setting and Temperature (50.0 k Ω , 8-bit: $V_L = 1.8\text{V}$, 2.7V, 5.5V, $A = V_+$, $B = V_-$, $\text{DGND} = V_-$, $V_+ = 36\text{V}$).

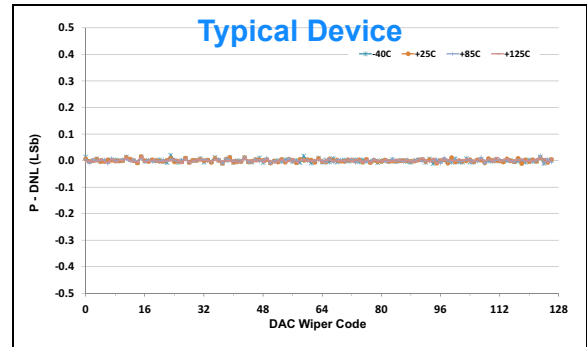

FIGURE 1-150: DNL Error - Pot. Mode (P-DNL) vs. Wiper Setting and Temperature (50.0 k Ω , 7-bit: $V_L = 1.8\text{V}$, 2.7V, 5.5V, $A = V_+$, $B = V_-$, $\text{DGND} = V_-$, $V_+ = 36\text{V}$).

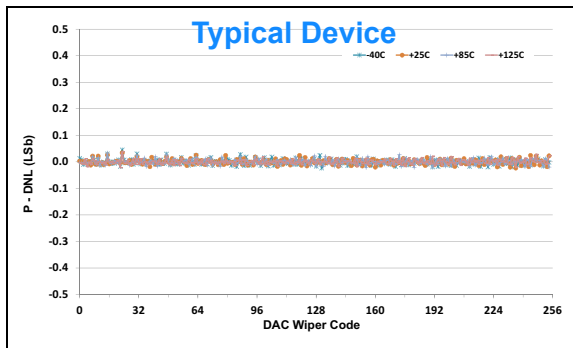

FIGURE 1-148: DNL Error - Pot. Mode (P-DNL) vs. Wiper Setting and Temperature (50.0 k Ω , 8-bit: $V_L = 1.8\text{V}$, 2.7V, 5.5V, $A = V_+$, $B = V_-$, $\text{DGND} = V_-$, $V_+ = 20\text{V}$).

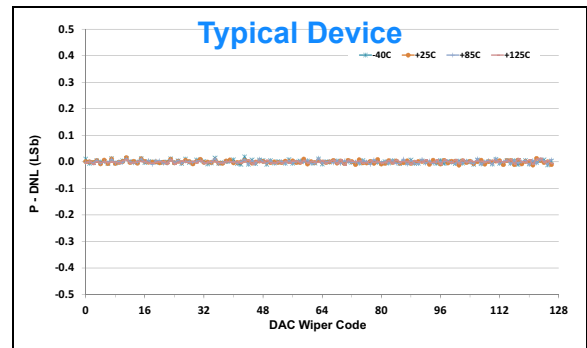

FIGURE 1-151: DNL Error - Pot. Mode (P-DNL) vs. Wiper Setting and Temperature (50.0 k Ω , 7-bit: $V_L = 1.8\text{V}$, 2.7V, 5.5V, $A = V_+$, $B = V_-$, $\text{DGND} = V_-$, $V_+ = 20\text{V}$).

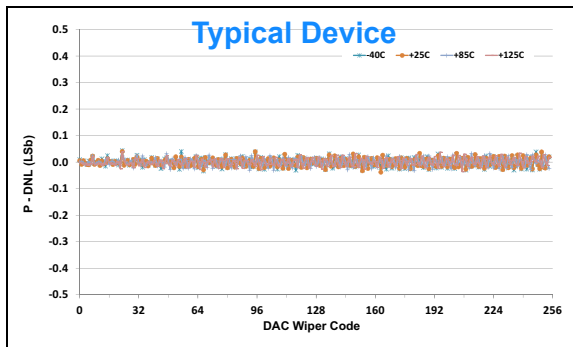

FIGURE 1-149: DNL Error - Pot. Mode (P-DNL) vs. Wiper Setting and Temperature (50.0 k Ω , 8-bit: $V_L = 1.8\text{V}$, 2.7V, 5.5V, $A = V_+$, $B = V_-$, $\text{DGND} = V_-$, $V_+ = 10\text{V}$).

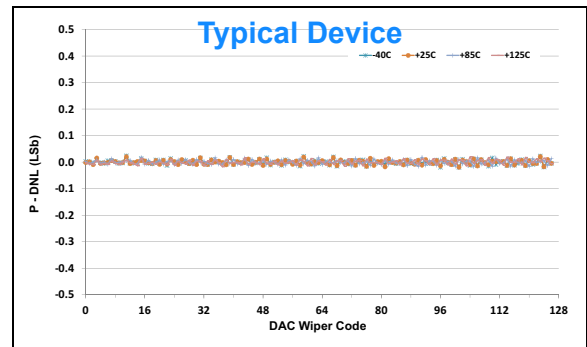

FIGURE 1-152: DNL Error - Pot. Mode (P-DNL) vs. Wiper Setting and Temperature (50.0 k Ω , 7-bit: $V_L = 1.8\text{V}$, 2.7V, 5.5V, $A = V_+$, $B = V_-$, $\text{DGND} = V_-$, $V_+ = 10\text{V}$).

MCP41HVX1

Note: Unless otherwise indicated, $T_A = +25^\circ\text{C}$, $V_L = 5.0\text{V}$, $\text{DGND} = V^-$, $V^+ = 36\text{V}$.

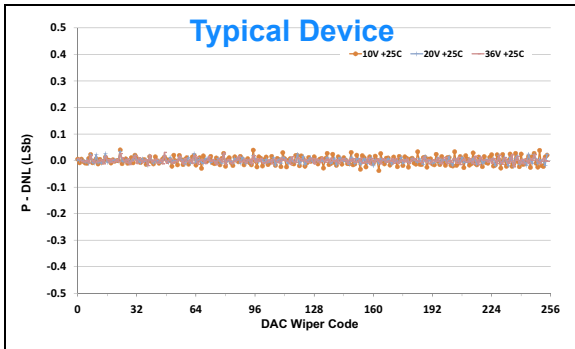

FIGURE 1-153: DNL Error - Pot. Mode (P-DNL) vs. Wiper Setting (@ 25°C) (50.0 kΩ, 8-bit: $V_L = 1.8\text{V}, 2.7\text{V}, 5.5\text{V}$, $A = V^+$, $B = V^-$, $\text{DGND} = V^-$, $V^+ = 36\text{V}, 20\text{V}, 10\text{V}$).

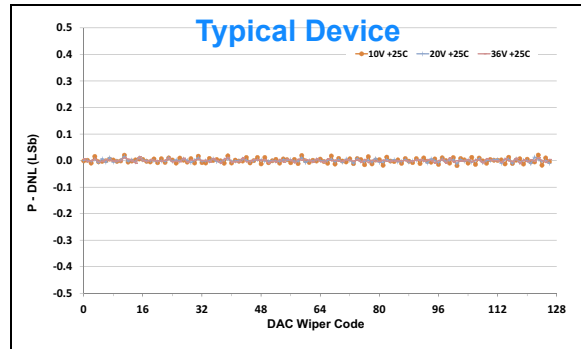

FIGURE 1-154: DNL Error - Pot. Mode (P-DNL) vs. Wiper Setting (@ 25°C) (50.0 kΩ, 7-bit: $V_L = 1.8\text{V}, 2.7\text{V}, 5.5\text{V}$, $A = V^+$, $B = V^-$, $\text{DGND} = V^-$, $V^+ = 36\text{V}, 20\text{V}, 10\text{V}$).

Note: Unless otherwise indicated, $T_A = +25^\circ\text{C}$, $V_L = 5.0\text{V}$, $\text{DGND} = V^-$, $V^+ = 36\text{V}$.

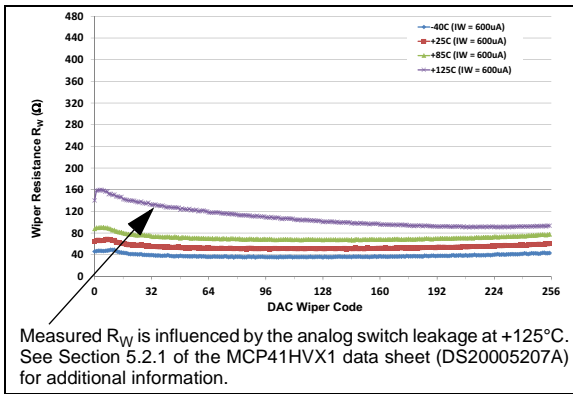

FIGURE 1-155: Wiper Resistance (R_W) vs. Wiper Setting and Temperature (50.0 kΩ, 8-bit: $V_L = 1.8\text{V}, 2.7\text{V}, 5.5\text{V}$, $A = V^+$, $B = V^-$, $\text{DGND} = V^-$, $V^+ = 36\text{V}$, $I_W = 600\ \mu\text{A}$).

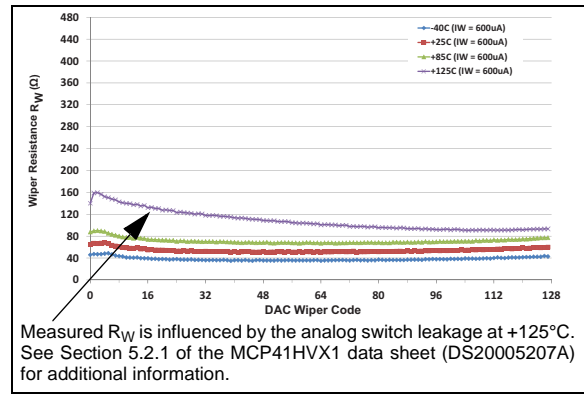

FIGURE 1-158: Wiper Resistance (R_W) vs. Wiper Setting and Temperature (50.0 kΩ, 7-bit: $V_L = 1.8\text{V}, 2.7\text{V}, 5.5\text{V}$, $A = V^+$, $B = V^-$, $\text{DGND} = V^-$, $V^+ = 36\text{V}$, $I_W = 600\ \mu\text{A}$).

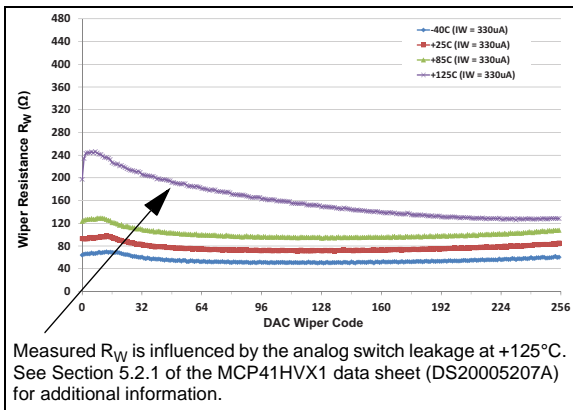

FIGURE 1-156: Wiper Resistance (R_W) vs. Wiper Setting and Temperature (50.0 kΩ, 8-bit: $V_L = 1.8\text{V}, 2.7\text{V}, 5.5\text{V}$, $A = V^+$, $B = V^-$, $\text{DGND} = V^-$, $V^+ = 20\text{V}$, $I_W = 330\ \mu\text{A}$).

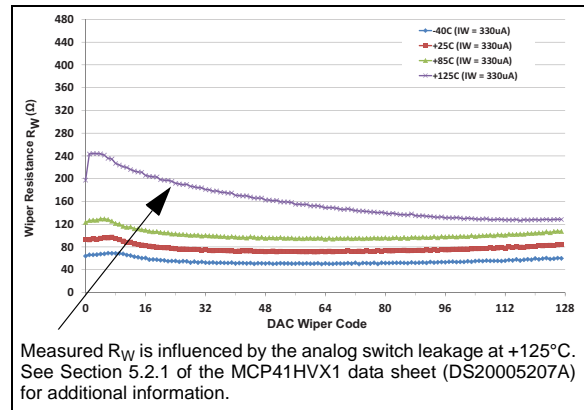

FIGURE 1-159: Wiper Resistance (R_W) vs. Wiper Setting and Temperature (50.0 kΩ, 7-bit: $V_L = 1.8\text{V}, 2.7\text{V}, 5.5\text{V}$, $A = V^+$, $B = V^-$, $\text{DGND} = V^-$, $V^+ = 20\text{V}$, $I_W = 330\ \mu\text{A}$).

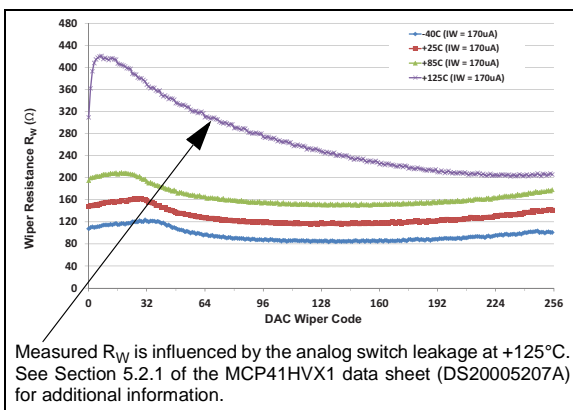

FIGURE 1-157: Wiper Resistance (R_W) vs. Wiper Setting and Temperature (50.0 kΩ, 8-bit: $V_L = 1.8\text{V}, 2.7\text{V}, 5.5\text{V}$, $A = V^+$, $B = V^-$, $\text{DGND} = V^-$, $V^+ = 10\text{V}$, $I_W = 170\ \mu\text{A}$).

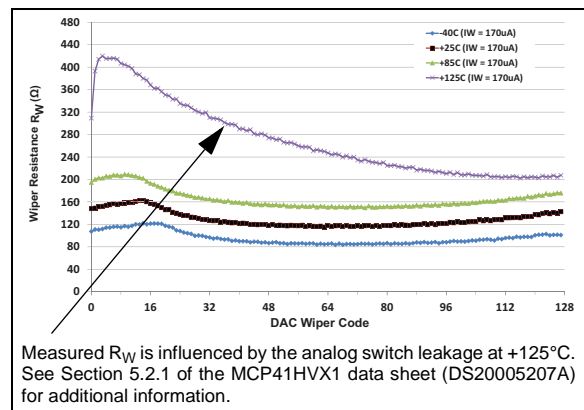

FIGURE 1-160: Wiper Resistance (R_W) vs. Wiper Setting and Temperature (50.0 kΩ, 7-bit: $V_L = 1.8\text{V}, 2.7\text{V}, 5.5\text{V}$, $A = V^+$, $B = V^-$, $\text{DGND} = V^-$, $V^+ = 10\text{V}$, $I_W = 170\ \mu\text{A}$).

MCP41HVX1

Note: Unless otherwise indicated, $T_A = +25^\circ\text{C}$, $V_L = 5.0\text{V}$, $\text{DGND} = V^-$, $V+ = 36\text{V}$.

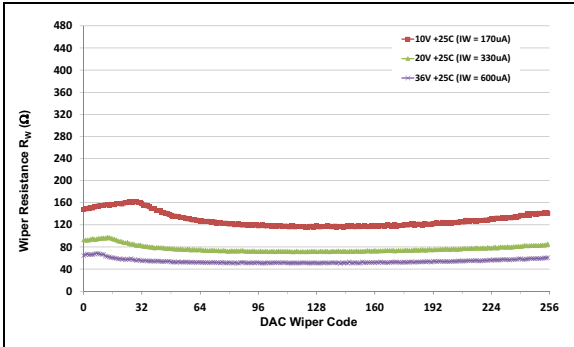

FIGURE 1-161: Wiper Resistance (R_W) vs. Wiper Setting @ 29°C
 ($50.0\text{ k}\Omega$, **8-bit**: $V_L = 1.8\text{V}, 2.7\text{V}, 5.5\text{V}$,
 $A = V+$, $B = V^-$, $\text{DGND} = V^-$,
 $V+ = 36\text{V}$ and $I_W = 600\text{ }\mu\text{A}$, $V+ = 20\text{V}$ and
 $I_W = 330\text{ }\mu\text{A}$, $V+ = 10\text{V}$ and $I_W = 170\text{ }\mu\text{A}$).

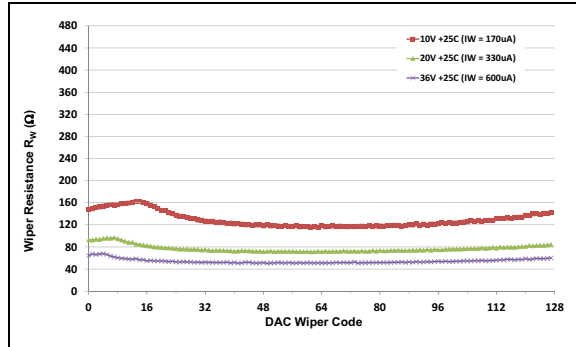

FIGURE 1-162: Wiper Resistance (R_W) vs. Wiper Setting @ 29°C
 ($50.0\text{ k}\Omega$, **7-bit**: $V_L = 1.8\text{V}, 2.7\text{V}, 5.5\text{V}$,
 $A = V+$, $B = V^-$, $\text{DGND} = V^-$,
 $V+ = 36\text{V}$ and $I_W = 600\text{ }\mu\text{A}$, $V+ = 20\text{V}$ and
 $I_W = 330\text{ }\mu\text{A}$, $V+ = 10\text{V}$ and $I_W = 170\text{ }\mu\text{A}$).

Note: Unless otherwise indicated, $T_A = +25^\circ\text{C}$, $V_L = 5.0\text{V}$, $\text{DGND} = V^-$, $V^+ = 36\text{V}$.

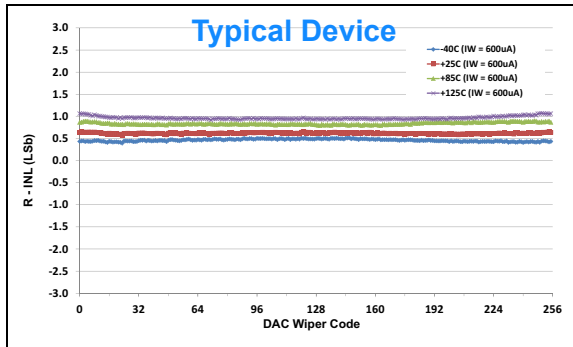

FIGURE 1-163: INL Error - Rheo. Mode (R-INL) vs. Wiper Setting and Temperature (50.0 kΩ, 8-bit: $V_L = 1.8\text{V}$, 2.7V, 5.5V, $A = V^+$, $B = V^-$, $\text{DGND} = V^-$, $V^+ = 36\text{V}$, $I_W = 600\ \mu\text{A}$).

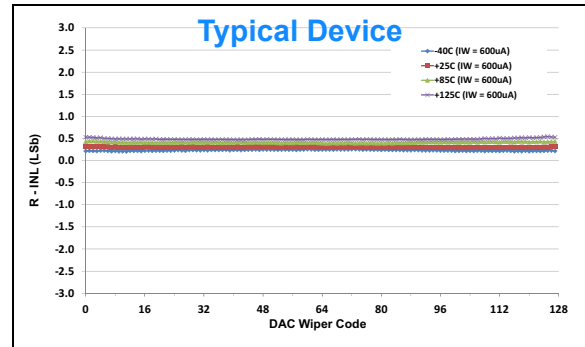

FIGURE 1-166: INL Error - Rheo. Mode (R-INL) vs. Wiper Setting and Temperature (50.0 kΩ, 7-bit: $V_L = 1.8\text{V}$, 2.7V, 5.5V, $A = V^+$, $B = V^-$, $\text{DGND} = V^-$, $V^+ = 36\text{V}$, $I_W = 600\ \mu\text{A}$).

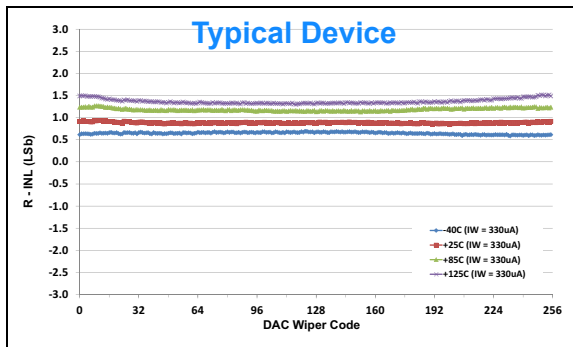

FIGURE 1-164: INL Error - Rheo. Mode (R-INL) vs. Wiper Setting and Temperature (50.0 kΩ, 8-bit: $V_L = 1.8\text{V}$, 2.7V, 5.5V, $A = V^+$, $B = V^-$, $\text{DGND} = V^-$, $V^+ = 20\text{V}$, $I_W = 330\ \mu\text{A}$).

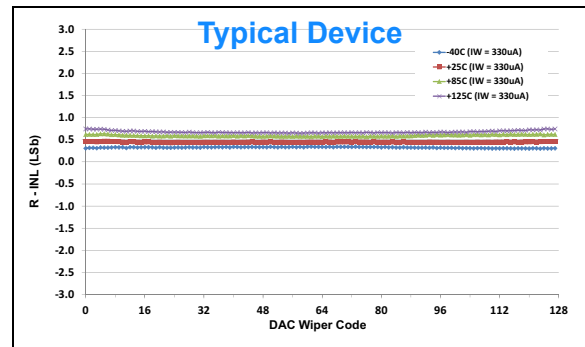

FIGURE 1-167: INL Error - Rheo. Mode (R-INL) vs. Wiper Setting and Temperature (50.0 kΩ, 7-bit: $V_L = 1.8\text{V}$, 2.7V, 5.5V, $A = V^+$, $B = V^-$, $\text{DGND} = V^-$, $V^+ = 20\text{V}$, $I_W = 330\ \mu\text{A}$).

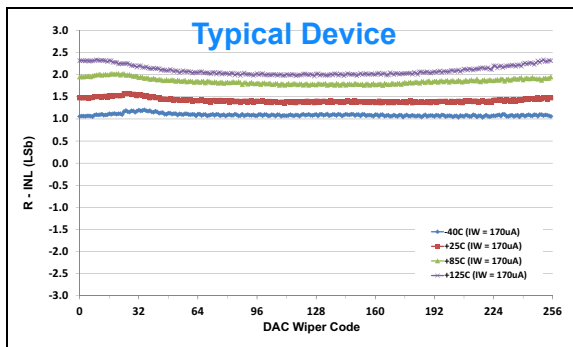

FIGURE 1-165: INL Error - Rheo. Mode (R-INL) vs. Wiper Setting and Temperature (50.0 kΩ, 8-bit: $V_L = 1.8\text{V}$, 2.7V, 5.5V, $A = V^+$, $B = V^-$, $\text{DGND} = V^-$, $V^+ = 10\text{V}$, $I_W = 170\ \mu\text{A}$).

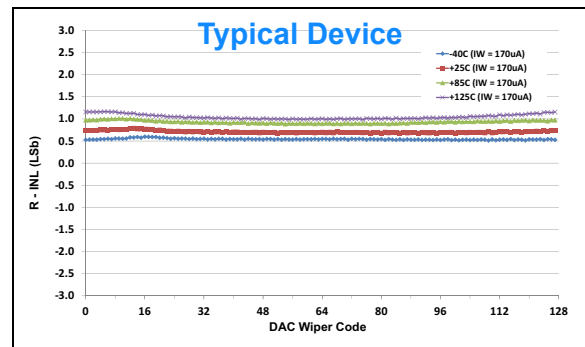

FIGURE 1-168: INL Error - Rheo. Mode (R-INL) vs. Wiper Setting and Temperature (50.0 kΩ, 7-bit: $V_L = 1.8\text{V}$, 2.7V, 5.5V, $A = V^+$, $B = V^-$, $\text{DGND} = V^-$, $V^+ = 10\text{V}$, $I_W = 170\ \mu\text{A}$).

MCP41HVX1

Note: Unless otherwise indicated, $T_A = +25^\circ\text{C}$, $V_L = 5.0\text{V}$, $\text{DGND} = V^-$, $V^+ = 36\text{V}$

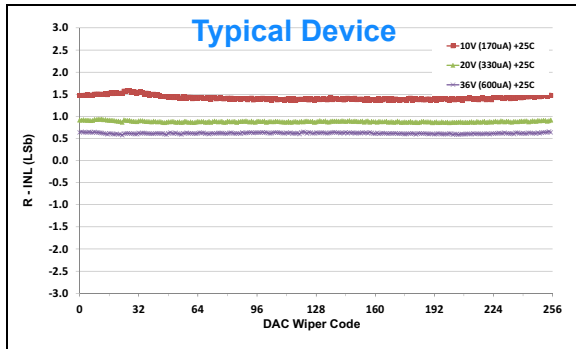

FIGURE 1-169: INL Error - Rheo. Mode (R-INL) vs. Wiper Setting (@ 25°C) (50.0 kΩ, 8-bit: $V_L = 1.8\text{V}$, 2.7V, 5.5V, $A = V^+$, $B = V^-$, $\text{DGND} = V^-$, $V^+ = 36\text{V}$ and $I_W = 600\ \mu\text{A}$, $V^+ = 20\text{V}$ and $I_W = 330\ \mu\text{A}$, $V^+ = 10\text{V}$ and $I_W = 170\ \mu\text{A}$).

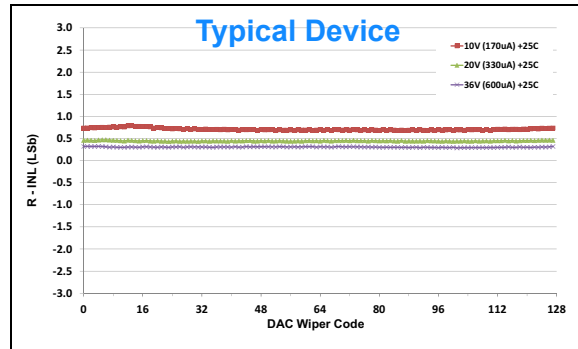

FIGURE 1-170: INL Error - Rheo. Mode (R-INL) vs. Wiper Setting (@ 25°C) (50.0 kΩ, 7-bit: $V_L = 1.8\text{V}$, 2.7V, 5.5V, $A = V^+$, $B = V^-$, $\text{DGND} = V^-$, $V^+ = 36\text{V}$ and $I_W = 600\ \mu\text{A}$, $V^+ = 20\text{V}$ and $I_W = 330\ \mu\text{A}$, $V^+ = 10\text{V}$ and $I_W = 170\ \mu\text{A}$).

Note: Unless otherwise indicated, $T_A = +25^\circ\text{C}$, $V_L = 5.0\text{V}$, $\text{DGND} = V_-$, $V_+ = 36\text{V}$.

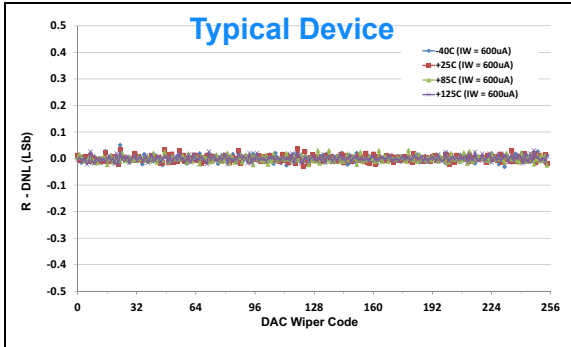

FIGURE 1-171: DNL Error - Rheo. Mode (R-DNL) vs. Wiper Setting and Temperature (50.0 kΩ, 8-bit: $V_L = 1.8\text{V}$, 2.7V, 5.5V, $A = V_+$, $B = V_-$, $\text{DGND} = V_-$, $V_+ = 36\text{V}$, $I_W = 600\ \mu\text{A}$).

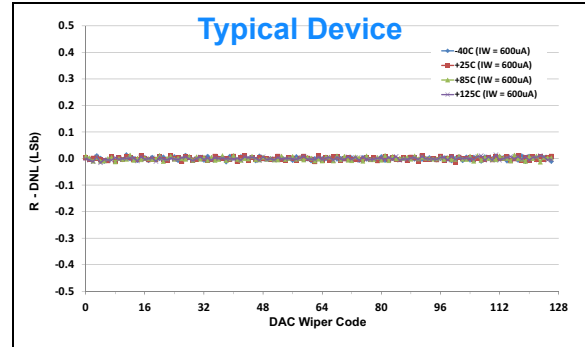

FIGURE 1-174: DNL Error - Rheo. Mode (R-DNL) vs. Wiper Setting and Temperature (50.0 kΩ, 7-bit: $V_L = 1.8\text{V}$, 2.7V, 5.5V, $A = V_+$, $B = V_-$, $\text{DGND} = V_-$, $V_+ = 36\text{V}$, $I_W = 600\ \mu\text{A}$).

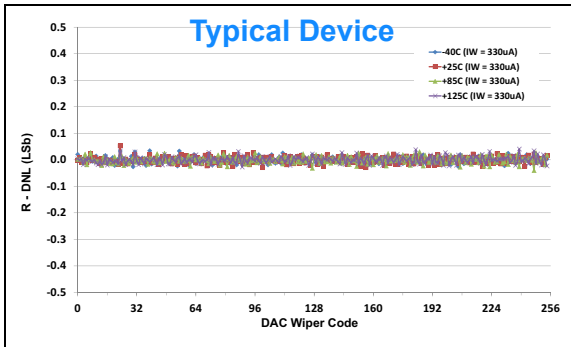

FIGURE 1-172: DNL Error - Rheo. Mode (R-DNL) vs. Wiper Setting and Temperature (50.0 kΩ, 8-bit: $V_L = 1.8\text{V}$, 2.7V, 5.5V, $A = V_+$, $B = V_-$, $\text{DGND} = V_-$, $V_+ = 20\text{V}$, $I_W = 330\ \mu\text{A}$).

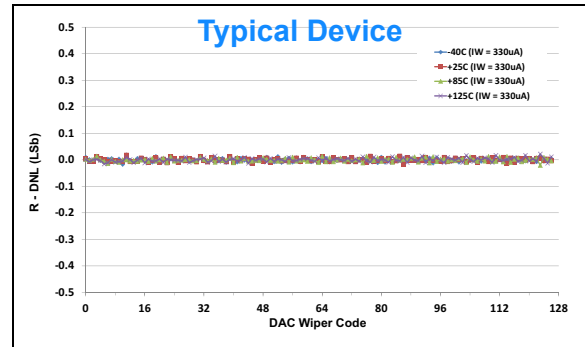

FIGURE 1-175: DNL Error - Rheo. Mode (R-DNL) vs. Wiper Setting and Temperature (50.0 kΩ, 7-bit: $V_L = 1.8\text{V}$, 2.7V, 5.5V, $A = V_+$, $B = V_-$, $\text{DGND} = V_-$, $V_+ = 20\text{V}$, $I_W = 330\ \mu\text{A}$).

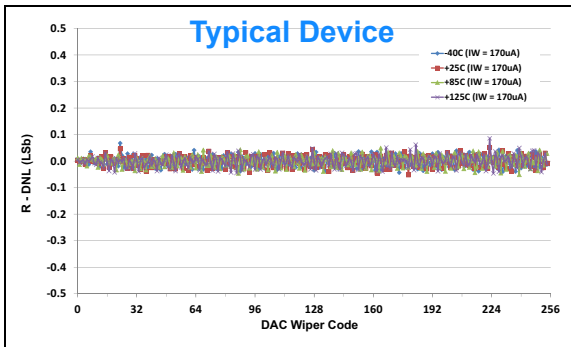

FIGURE 1-173: DNL Error - Rheo. Mode (R-DNL) vs. Wiper Setting and Temperature (50.0 kΩ, 8-bit: $V_L = 1.8\text{V}$, 2.7V, 5.5V, $A = V_+$, $B = V_-$, $\text{DGND} = V_-$, $V_+ = 10\text{V}$, $I_W = 170\ \mu\text{A}$).

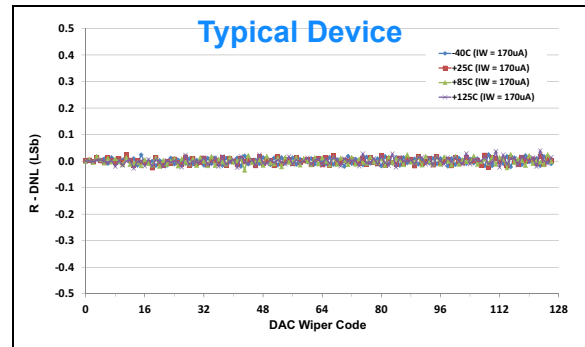

FIGURE 1-176: DNL Error - Rheo. Mode (R-DNL) vs. Wiper Setting and Temperature (50.0 kΩ, 7-bit: $V_L = 1.8\text{V}$, 2.7V, 5.5V, $A = V_+$, $B = V_-$, $\text{DGND} = V_-$, $V_+ = 10\text{V}$, $I_W = 170\ \mu\text{A}$).

MCP41HVX1

Note: Unless otherwise indicated, $T_A = +25^\circ\text{C}$, $V_L = 5.0\text{V}$, $\text{DGND} = V_-$, $V_+ = 36\text{V}$.

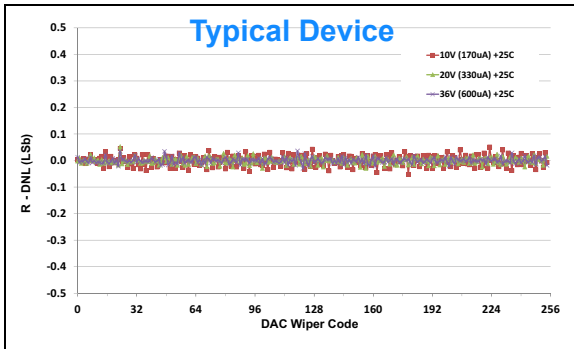

FIGURE 1-177: DNL Error - Rheo. Mode (R-DNL) vs. Wiper Setting (@ 25°C) ($50.0\text{ k}\Omega$, **8-bit**: $V_L = 1.8\text{V}$, 2.7V , 5.5V , $A = V_+$, $B = V_-$, $\text{DGND} = V_-$, $V_+ = 36\text{V}$ and $I_W = 600\text{ }\mu\text{A}$, $V_+ = 20\text{V}$ and $I_W = 330\text{ }\mu\text{A}$, $V_+ = 10\text{V}$ and $I_W = 170\text{ }\mu\text{A}$).

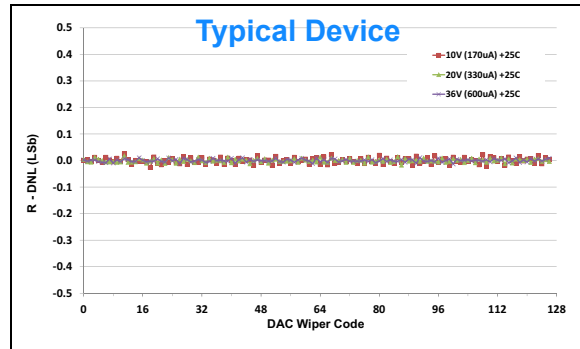

FIGURE 1-178: DNL Error - Rheo. Mode (R-DNL) vs. Wiper Setting (@ 25°C) ($50.0\text{ k}\Omega$, **7-bit**: $V_L = 1.8\text{V}$, 2.7V , 5.5V , $A = V_+$, $B = V_-$, $\text{DGND} = V_-$, $V_+ = 36\text{V}$ and $I_W = 600\text{ }\mu\text{A}$, $V_+ = 20\text{V}$ and $I_W = 330\text{ }\mu\text{A}$, $V_+ = 10\text{V}$ and $I_W = 170\text{ }\mu\text{A}$).

Note: Unless otherwise indicated, $T_A = +25^\circ\text{C}$, $V_L = 5.0\text{V}$, $\text{DGND} = \text{V-}$, $\text{V+} = 36\text{V}$.

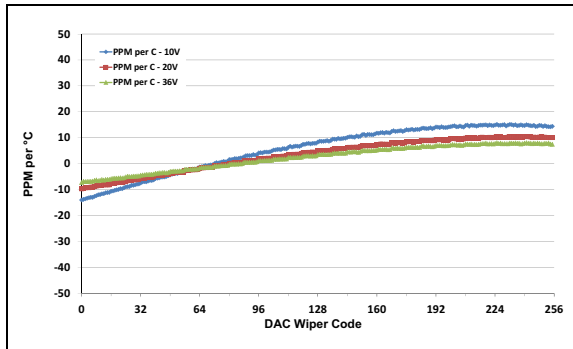

FIGURE 1-179: $V_W \text{ PPM}/^\circ\text{C}$ (Pot. Mode) vs. Temperature, and $V+$ Voltage

$$\left(\frac{V_{W(\text{code}=n, 125^\circ\text{C})} - V_{W(\text{code}=n, -40^\circ\text{C})}}{V_{W(\text{code}=255, 25^\circ\text{C})}} \right) * 1,000,000 / 165^\circ\text{C}$$

(50.0 k Ω , 8-bit: $V_L = 1.8\text{V}, 2.7\text{V}, 5.5\text{V}$,
 $A = \text{V+}$, $B = \text{V-}$, $\text{DGND} = \text{V-}$, $\text{V+} = 36\text{V}, 20\text{V}, 10\text{V}$).

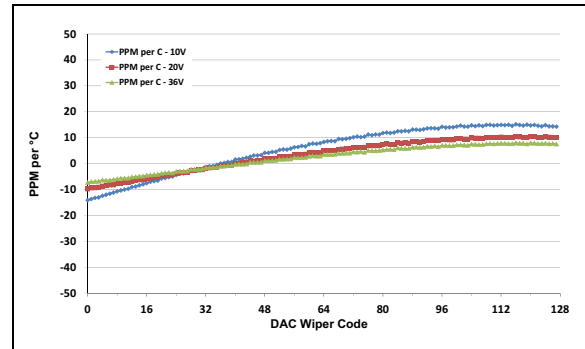

FIGURE 1-180: $V_W \text{ PPM}/^\circ\text{C}$ (Pot. Mode) vs. Temperature, and $V+$ Voltage

$$\left(\frac{V_{W(\text{code}=n, 125^\circ\text{C})} - V_{W(\text{code}=n, -40^\circ\text{C})}}{V_{W(\text{code}=127, 25^\circ\text{C})}} \right) * 1,000,000 / 165^\circ\text{C}$$

(50.0 k Ω , 7-bit: $V_L = 1.8\text{V}, 2.7\text{V}, 5.5\text{V}$,
 $A = \text{V+}$, $B = \text{V-}$, $\text{DGND} = \text{V-}$, $\text{V+} = 36\text{V}, 20\text{V}, 10\text{V}$).

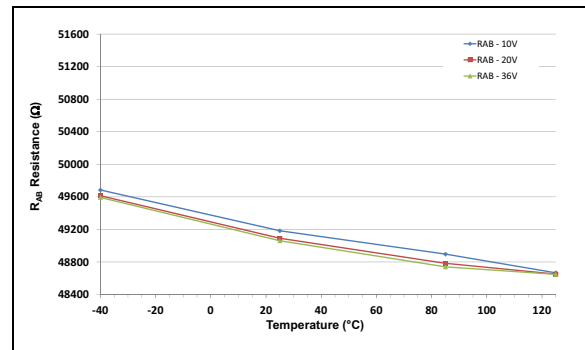

FIGURE 1-181: R_{AB} Resistance vs. Temperature and $V+$ Voltage

(50.0 k Ω : $V_L = 1.8\text{V}, 2.7\text{V}, 5.5\text{V}$,
 $A = \text{V+}$, $B = \text{V-}$, $\text{DGND} = \text{V-}$, $\text{V+} = 36\text{V}, 20\text{V}, 10\text{V}$).

MCP41HVX1

Note: Unless otherwise indicated, $T_A = +25^\circ\text{C}$, $V_L = 5.0\text{V}$, $\text{DGND} = \text{V-}$, $\text{V+} = 36\text{V}$.

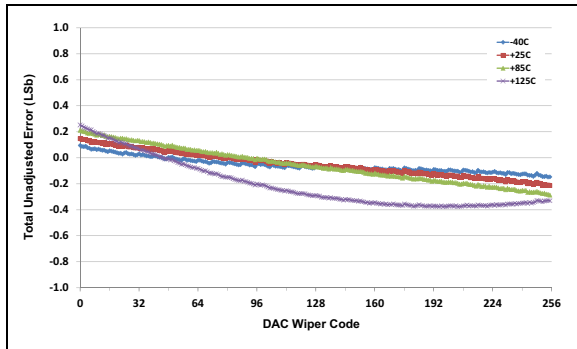

FIGURE 1-182: Total Unadjusted Error (Pot. Mode) (V_W) vs. Wiper Setting and Temperature (100.0 k Ω , 8-bit: $V_L = 1.8\text{V}, 2.7\text{V}, 5.5\text{V}$, $A = \text{V+}$, $B = \text{V-}$, $\text{DGND} = \text{V-}$, $\text{V+} = 36\text{V}$).

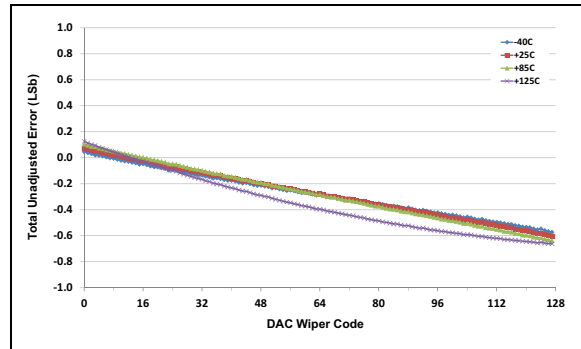

FIGURE 1-185: Total Unadjusted Error (Pot. Mode) (V_W) vs. Wiper Setting and Temperature (100.0 k Ω , 7-bit: $V_L = 1.8\text{V}, 2.7\text{V}, 5.5\text{V}$, $A = \text{V+}$, $B = \text{V-}$, $\text{DGND} = \text{V-}$, $\text{V+} = 36\text{V}$).

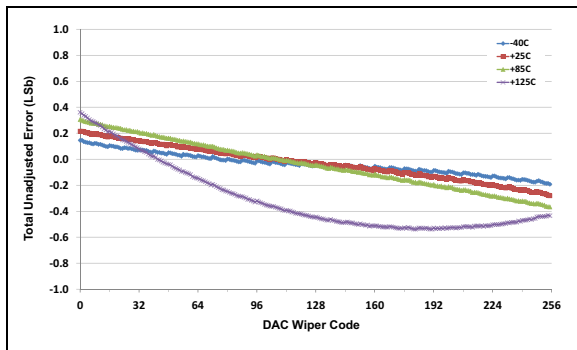

FIGURE 1-183: Total Unadjusted Error (Pot. Mode) (V_W) vs. Wiper Setting and Temperature (100.0 k Ω , 8-bit: $V_L = 1.8\text{V}, 2.7\text{V}, 5.5\text{V}$, $A = \text{V+}$, $B = \text{V-}$, $\text{DGND} = \text{V-}$, $\text{V+} = 20\text{V}$).

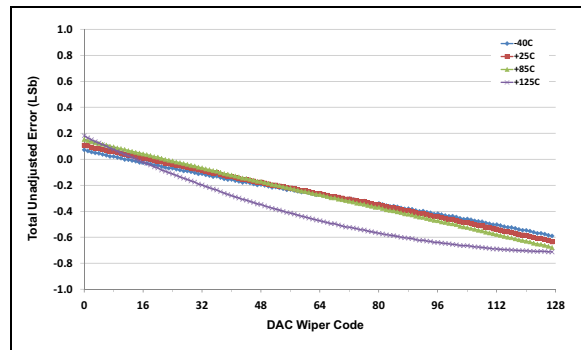

FIGURE 1-186: Total Unadjusted Error (Pot. Mode) (V_W) vs. Wiper Setting and Temperature (100.0 k Ω , 7-bit: $V_L = 1.8\text{V}, 2.7\text{V}, 5.5\text{V}$, $A = \text{V+}$, $B = \text{V-}$, $\text{DGND} = \text{V-}$, $\text{V+} = 20\text{V}$).

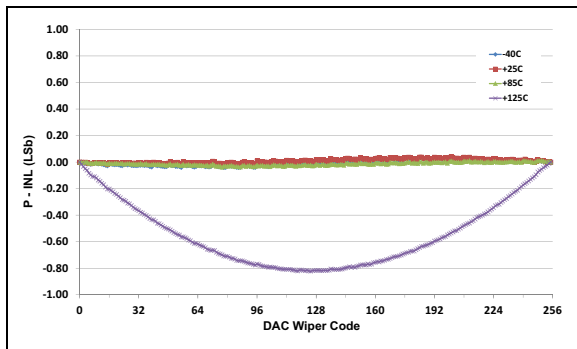

FIGURE 1-184: Total Unadjusted Error (Pot. Mode) (V_W) vs. Wiper Setting and Temperature (100.0 k Ω , 8-bit: $V_L = 1.8\text{V}, 2.7\text{V}, 5.5\text{V}$, $A = \text{V+}$, $B = \text{V-}$, $\text{DGND} = \text{V-}$, $\text{V+} = 10\text{V}$).

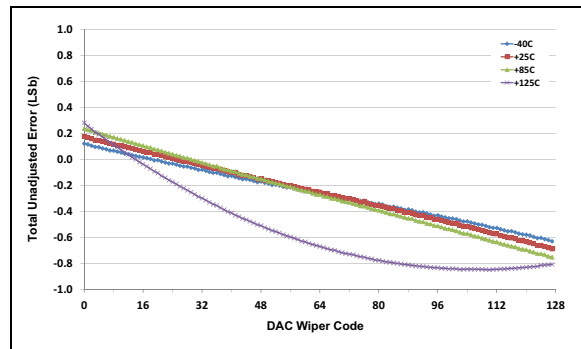

FIGURE 1-187: Total Unadjusted Error (Pot. Mode) (V_W) vs. Wiper Setting and Temperature (100.0 k Ω , 7-bit: $V_L = 1.8\text{V}, 2.7\text{V}, 5.5\text{V}$, $A = \text{V+}$, $B = \text{V-}$, $\text{DGND} = \text{V-}$, $\text{V+} = 10\text{V}$).

Note: Unless otherwise indicated, $T_A = +25^\circ\text{C}$, $V_L = 5.0\text{V}$, $\text{DGND} = V^-$, $V^+ = 36\text{V}$.

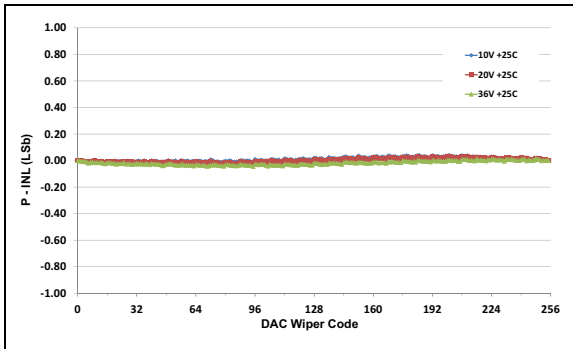

FIGURE 1-188: Total Unadjusted Error (Pot. Mode) (V_W) vs. Wiper Setting (@ 25°C) ($100.0\text{ k}\Omega$, **8-bit**: $V_L = 1.8\text{V}, 2.7\text{V}, 5.5\text{V}$, $A = V^+$, $B = V^-$, $\text{DGND} = V^-$, $V^+ = 36\text{V}, 20\text{V}, 10\text{V}$).

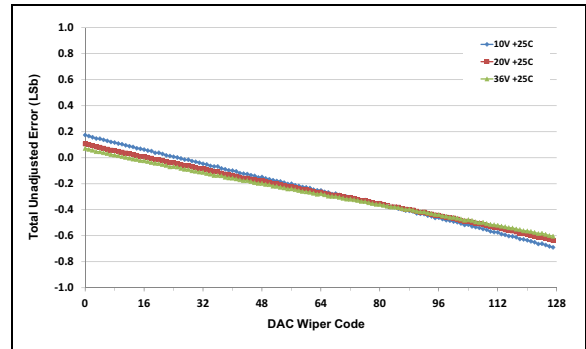

FIGURE 1-191: Total Unadjusted Error (Pot. Mode) (V_W) vs. Wiper Setting (@ 25°C) ($100.0\text{ k}\Omega$, **7-bit**: $V_L = 1.8\text{V}, 2.7\text{V}, 5.5\text{V}$, $A = V^+$, $B = V^-$, $\text{DGND} = V^-$, $V^+ = 36\text{V}, 20\text{V}, 10\text{V}$).

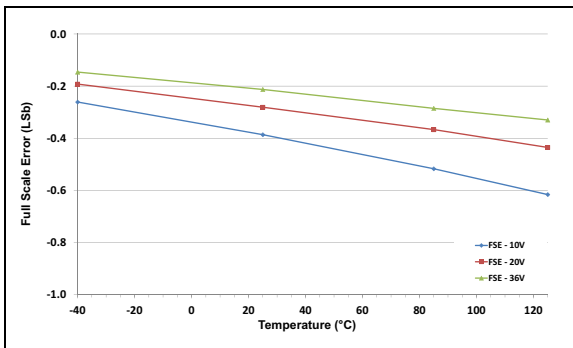

FIGURE 1-189: Full Scale Error (Pot. Mode) (FSE) vs. Temperature and V^+ Voltage ($100.0\text{ k}\Omega$, **8-bit**: $V_L = 1.8\text{V}, 2.7\text{V}, 5.5\text{V}$, $A = V^+$, $B = V^-$, $\text{DGND} = V^-$, $V^+ = 36\text{V}, 20\text{V}, 10\text{V}$).

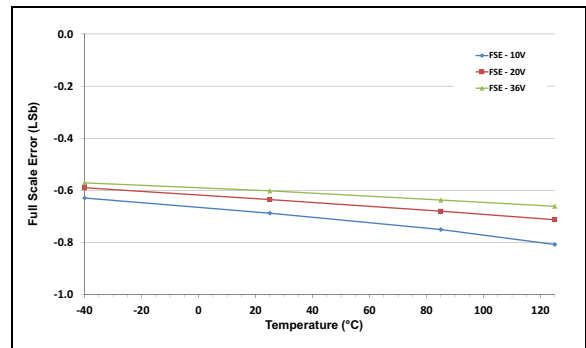

FIGURE 1-192: Full Scale Error (Pot. Mode) (FSE) vs. Temperature and V^+ Voltage ($100.0\text{ k}\Omega$, **7-bit**: $V_L = 1.8\text{V}, 2.7\text{V}, 5.5\text{V}$, $A = V^+$, $B = V^-$, $\text{DGND} = V^-$, $V^+ = 36\text{V}, 20\text{V}, 10\text{V}$).

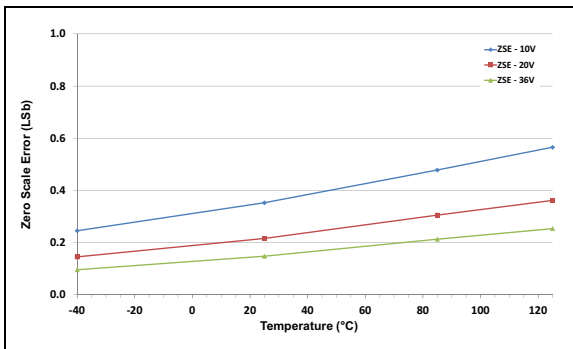

FIGURE 1-190: Zero Scale Error (Pot. Mode) (ZSE) vs. Temperature and V^+ Voltage ($100.0\text{ k}\Omega$, **8-bit**: $V_L = 1.8\text{V}, 2.7\text{V}, 5.5\text{V}$, $A = V^+$, $B = V^-$, $\text{DGND} = V^-$, $V^+ = 36\text{V}, 20\text{V}, 10\text{V}$).

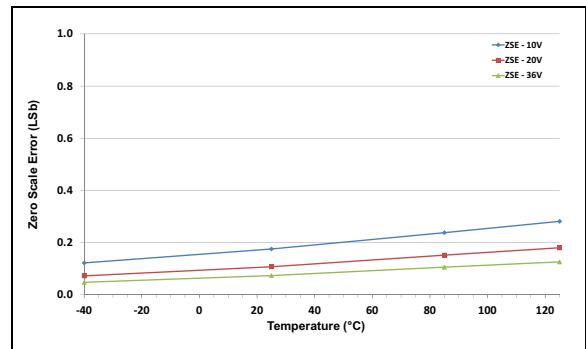

FIGURE 1-193: Zero Scale Error (Pot. Mode) (ZSE) vs. Temperature and V^+ Voltage ($100.0\text{ k}\Omega$, **7-bit**: $V_L = 1.8\text{V}, 2.7\text{V}, 5.5\text{V}$, $A = V^+$, $B = V^-$, $\text{DGND} = V^-$, $V^+ = 36\text{V}, 20\text{V}, 10\text{V}$).

MCP41HVX1

Note: Unless otherwise indicated, $T_A = +25^\circ\text{C}$, $V_L = 5.0\text{V}$, $\text{DGND} = \text{V-}$, $\text{V+} = 36\text{V}$.

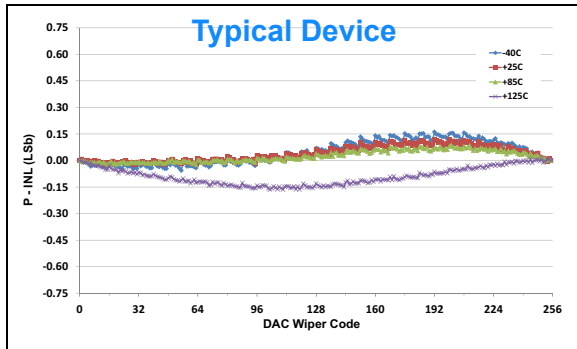

FIGURE 1-194: INL Error - Pot. Mode (P-INL) vs. Wiper Setting and Temperature (100.0 kΩ, 8-bit: $V_L = 1.8\text{V}, 2.7\text{V}, 5.5\text{V}$, $A = \text{V+}$, $B = \text{V-}$, $\text{DGND} = \text{V-}$, $\text{V+} = 36\text{V}$).

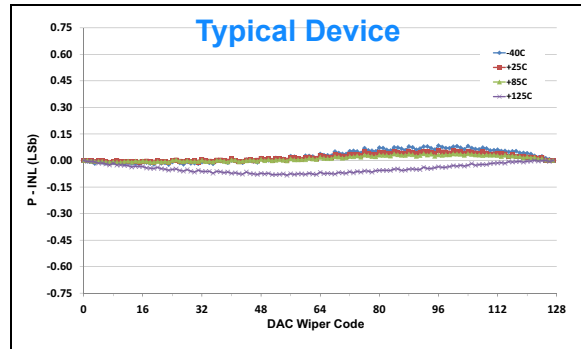

FIGURE 1-197: INL Error - Pot. Mode (P-INL) vs. Wiper Setting and Temperature (100.0 kΩ, 7-bit: $V_L = 1.8\text{V}, 2.7\text{V}, 5.5\text{V}$, $A = \text{V+}$, $B = \text{V-}$, $\text{DGND} = \text{V-}$, $\text{V+} = 36\text{V}$).

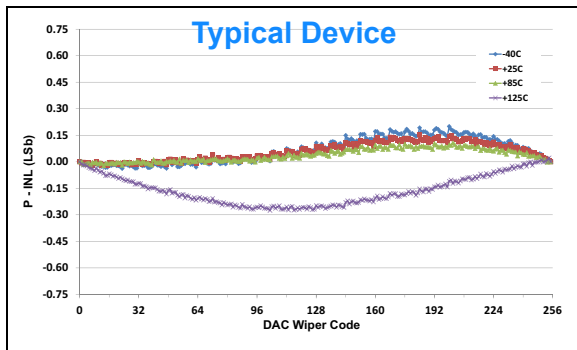

FIGURE 1-195: INL Error - Pot. Mode (P-INL) vs. Wiper Setting and Temperature (100.0 kΩ, 8-bit: $V_L = 1.8\text{V}, 2.7\text{V}, 5.5\text{V}$, $A = \text{V+}$, $B = \text{V-}$, $\text{DGND} = \text{V-}$, $\text{V+} = 20\text{V}$).

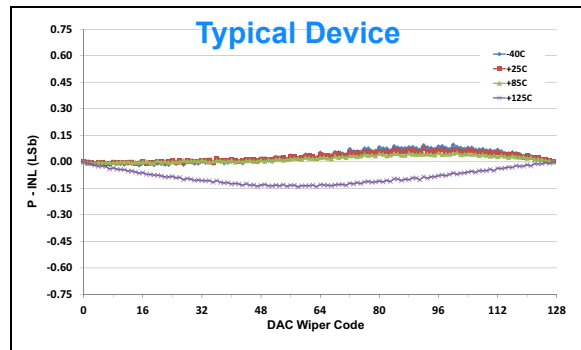

FIGURE 1-198: INL Error - Pot. Mode (P-INL) vs. Wiper Setting and Temperature (100.0 kΩ, 7-bit: $V_L = 1.8\text{V}, 2.7\text{V}, 5.5\text{V}$, $A = \text{V+}$, $B = \text{V-}$, $\text{DGND} = \text{V-}$, $\text{V+} = 20\text{V}$).

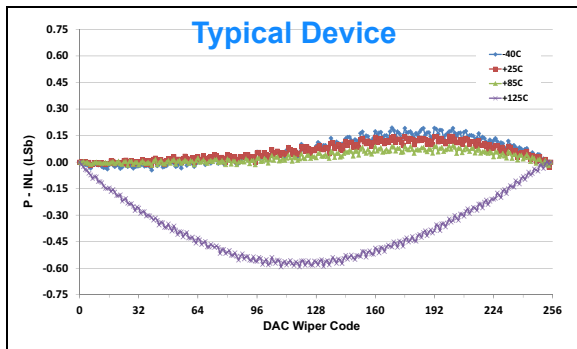

FIGURE 1-196: INL Error - Pot. Mode (P-INL) vs. Wiper Setting and Temperature (100.0 kΩ, 8-bit: $V_L = 1.8\text{V}, 2.7\text{V}, 5.5\text{V}$, $A = \text{V+}$, $B = \text{V-}$, $\text{DGND} = \text{V-}$, $\text{V+} = 10\text{V}$).

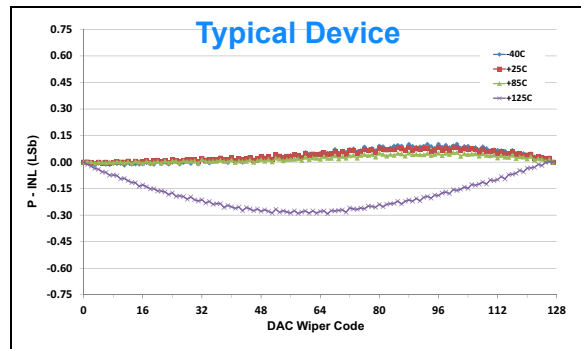

FIGURE 1-199: INL Error - Pot. Mode (P-INL) vs. Wiper Setting and Temperature (100.0 kΩ, 7-bit: $V_L = 1.8\text{V}, 2.7\text{V}, 5.5\text{V}$, $A = \text{V+}$, $B = \text{V-}$, $\text{DGND} = \text{V-}$, $\text{V+} = 10\text{V}$).

Note: Unless otherwise indicated, $T_A = +25^\circ\text{C}$, $V_L = 5.0\text{V}$, $\text{DGND} = V^-$, $V^+ = 36\text{V}$.

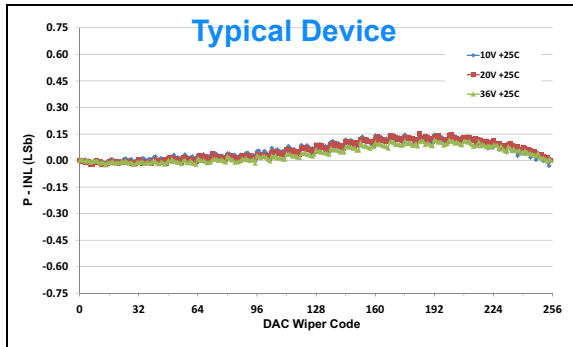

FIGURE 1-200: INL Error - Pot. Mode (P-INL) vs. Wiper Setting (@ 25°C)
 ($100.0\text{ k}\Omega$, **8-bit**: $V_L = 1.8\text{V}, 2.7\text{V}, 5.5\text{V}$,
 $A = V^+$, $B = V^-$, $\text{DGND} = V^-$, $V^+ = 36\text{V}, 20\text{V}, 10\text{V}$).

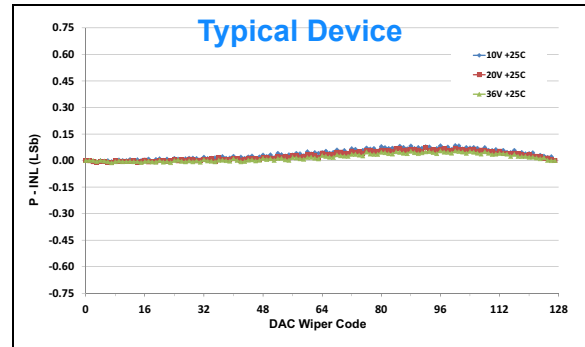

FIGURE 1-201: INL Error - Pot. Mode (P-INL) vs. Wiper Setting (@ 25°C)
 ($100.0\text{ k}\Omega$, **7-bit**: $V_L = 1.8\text{V}, 2.7\text{V}, 5.5\text{V}$,
 $A = V^+$, $B = V^-$, $\text{DGND} = V^-$, $V^+ = 36\text{V}, 20\text{V}, 10\text{V}$).

MCP41HVX1

Note: Unless otherwise indicated, $T_A = +25^\circ\text{C}$, $V_L = 5.0\text{V}$, $\text{DGND} = \text{V-}$, $\text{V+} = 36\text{V}$.

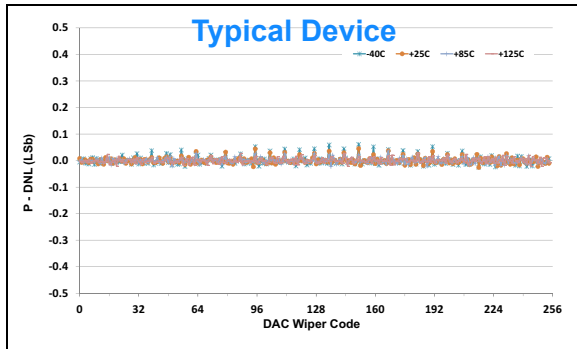

FIGURE 1-202: DNL Error - Pot. Mode (P-DNL) vs. Wiper Setting and Temperature (100.0 kΩ, 8-bit: $V_L = 1.8\text{V}$, 2.7V, 5.5V, $A = \text{V+}$, $B = \text{V-}$, $\text{DGND} = \text{V-}$, $\text{V+} = 36\text{V}$).

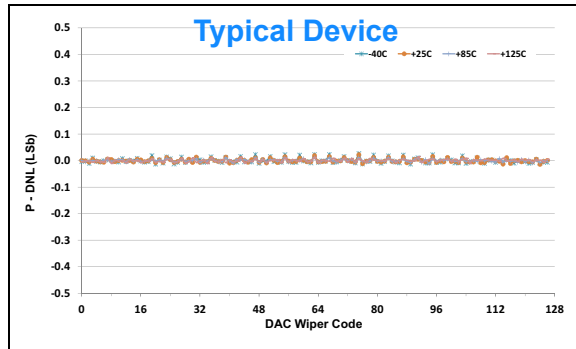

FIGURE 1-205: DNL Error - Pot. Mode (P-DNL) vs. Wiper Setting and Temperature (100.0 kΩ, 7-bit: $V_L = 1.8\text{V}$, 2.7V, 5.5V, $A = \text{V+}$, $B = \text{V-}$, $\text{DGND} = \text{V-}$, $\text{V+} = 36\text{V}$).

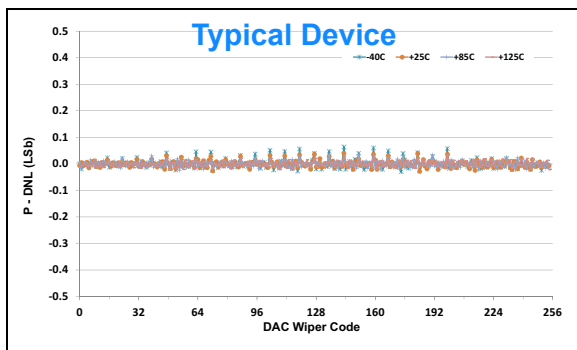

FIGURE 1-203: DNL Error - Pot. Mode (P-DNL) vs. Wiper Setting and Temperature (100.0 kΩ, 8-bit: $V_L = 1.8\text{V}$, 2.7V, 5.5V, $A = \text{V+}$, $B = \text{V-}$, $\text{DGND} = \text{V-}$, $\text{V+} = 20\text{V}$).

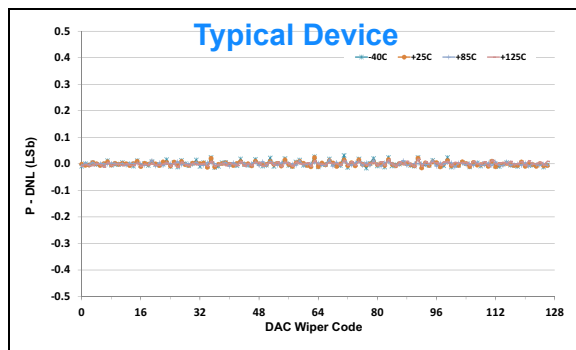

FIGURE 1-206: DNL Error - Pot. Mode (P-DNL) vs. Wiper Setting and Temperature (100.0 kΩ, 7-bit: $V_L = 1.8\text{V}$, 2.7V, 5.5V, $A = \text{V+}$, $B = \text{V-}$, $\text{DGND} = \text{V-}$, $\text{V+} = 20\text{V}$).

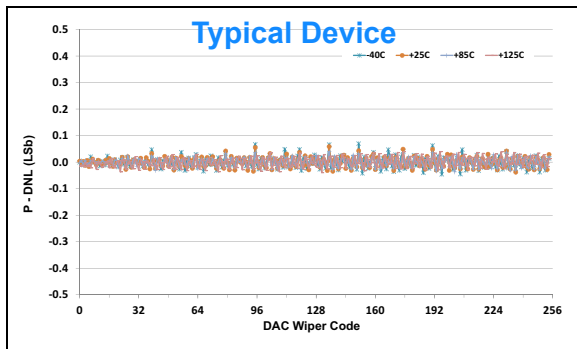

FIGURE 1-204: DNL Error - Pot. Mode (P-DNL) vs. Wiper Setting and Temperature (100.0 kΩ, 8-bit: $V_L = 1.8\text{V}$, 2.7V, 5.5V, $A = \text{V+}$, $B = \text{V-}$, $\text{DGND} = \text{V-}$, $\text{V+} = 10\text{V}$).

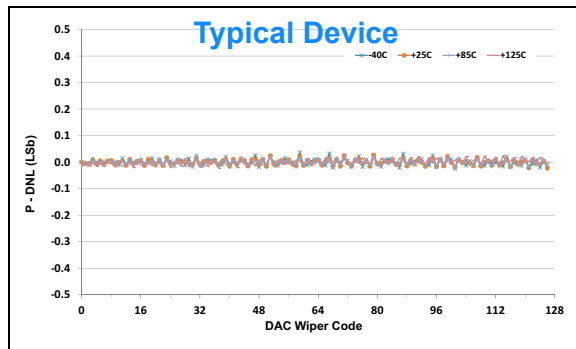

FIGURE 1-207: DNL Error - Pot. Mode (P-DNL) vs. Wiper Setting and Temperature (100.0 kΩ, 7-bit: $V_L = 1.8\text{V}$, 2.7V, 5.5V, $A = \text{V+}$, $B = \text{V-}$, $\text{DGND} = \text{V-}$, $\text{V+} = 10\text{V}$).

Note: Unless otherwise indicated, $T_A = +25^\circ\text{C}$, $V_L = 5.0\text{V}$, $\text{DGND} = V_-$, $V_+ = 36\text{V}$.

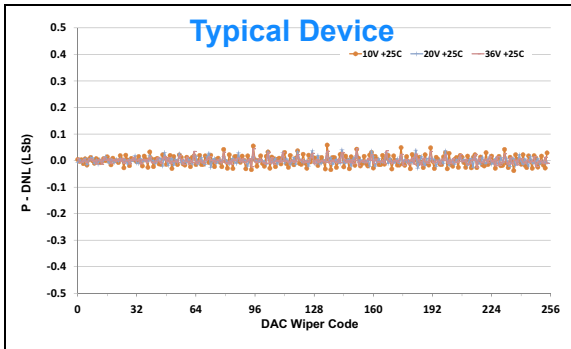

FIGURE 1-208: DNL Error - Pot. Mode (P-DNL) vs. Wiper Setting (@ 25°C) (100.0 kΩ, 8-bit: $V_L = 1.8\text{V}, 2.7\text{V}, 5.5\text{V}$, $A = V_+$, $B = V_-$, $\text{DGND} = V_-$, $V_+ = 36\text{V}, 20\text{V}, 10\text{V}$).

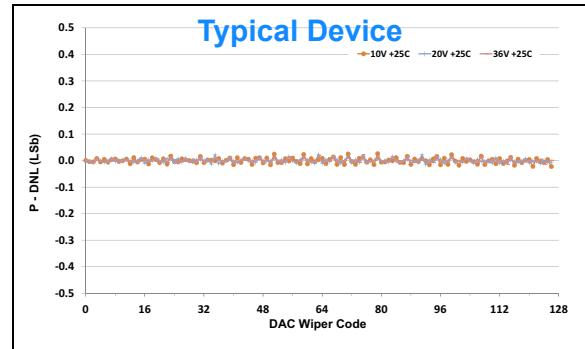
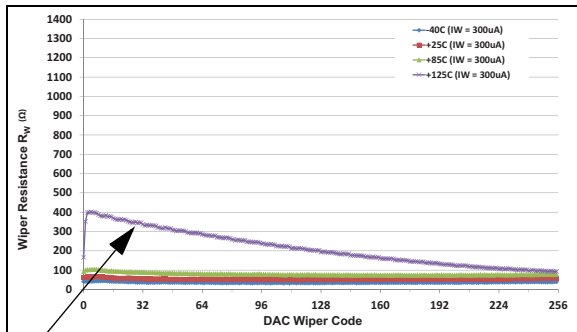

FIGURE 1-209: DNL Error - Pot. Mode (P-DNL) vs. Wiper Setting (@ 25°C) (100.0 kΩ, 7-bit: $V_L = 1.8\text{V}, 2.7\text{V}, 5.5\text{V}$, $A = V_+$, $B = V_-$, $\text{DGND} = V_-$, $V_+ = 36\text{V}, 20\text{V}, 10\text{V}$).

MCP41HVX1

Note: Unless otherwise indicated, $T_A = +25^\circ\text{C}$, $V_L = 5.0\text{V}$, $\text{DGND} = \text{V-}$, $\text{V+} = 36\text{V}$.



Measured R_W is influenced by the analog switch leakage at $+125^\circ\text{C}$. See Section 5.2.1 of the MCP41HVX1 data sheet (DS20005207A) for additional information.

FIGURE 1-210: Wiper Resistance (R_W) vs. Wiper Setting and Temperature
($100.0\text{ k}\Omega$, **8-bit**: $V_L = 1.8\text{V}, 2.7\text{V}, 5.5\text{V}$, $A = \text{V+}$, $B = \text{V-}$, $\text{DGND} = \text{V-}$, $\text{V+} = 36\text{V}$, $I_W = 300\text{ }\mu\text{A}$).

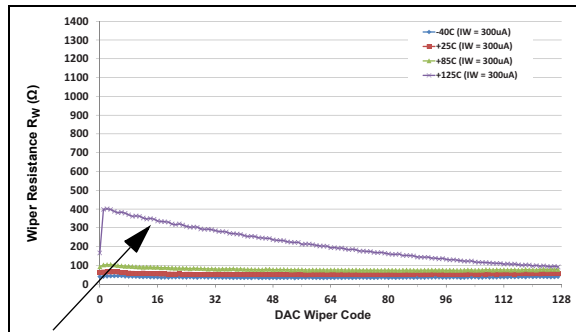

Measured R_W is influenced by the analog switch leakage at $+125^\circ\text{C}$. See Section 5.2.1 of the MCP41HVX1 data sheet (DS20005207A) for additional information.

FIGURE 1-213: Wiper Resistance (R_W) vs. Wiper Setting and Temperature
($100.0\text{ k}\Omega$, **7-bit**: $V_L = 1.8\text{V}, 2.7\text{V}, 5.5\text{V}$, $A = \text{V+}$, $B = \text{V-}$, $\text{DGND} = \text{V-}$, $\text{V+} = 36\text{V}$, $I_W = 300\text{ }\mu\text{A}$).

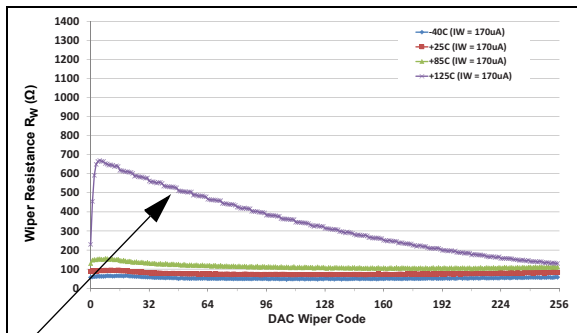

Measured R_W is influenced by the analog switch leakage at $+125^\circ\text{C}$. See Section 5.2.1 of the MCP41HVX1 data sheet (DS20005207A) for additional information.

FIGURE 1-211: Wiper Resistance (R_W) vs. Wiper Setting and Temperature
($100.0\text{ k}\Omega$, **8-bit**: $V_L = 1.8\text{V}, 2.7\text{V}, 5.5\text{V}$, $A = \text{V+}$, $B = \text{V-}$, $\text{DGND} = \text{V-}$, $\text{V+} = 20\text{V}$, $I_W = 170\text{ }\mu\text{A}$).

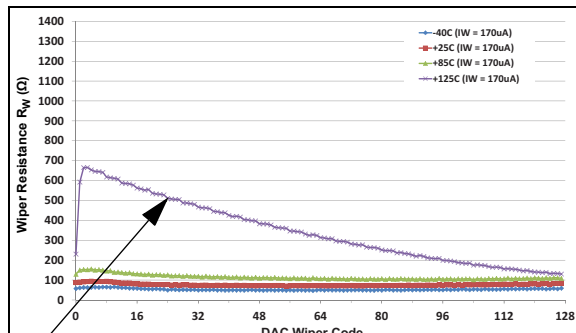

Measured R_W is influenced by the analog switch leakage at $+125^\circ\text{C}$. See Section 5.2.1 of the MCP41HVX1 data sheet (DS20005207A) for additional information.

FIGURE 1-214: Wiper Resistance (R_W) vs. Wiper Setting and Temperature
($100.0\text{ k}\Omega$, **7-bit**: $V_L = 1.8\text{V}, 2.7\text{V}, 5.5\text{V}$, $A = \text{V+}$, $B = \text{V-}$, $\text{DGND} = \text{V-}$, $\text{V+} = 20\text{V}$, $I_W = 170\text{ }\mu\text{A}$).

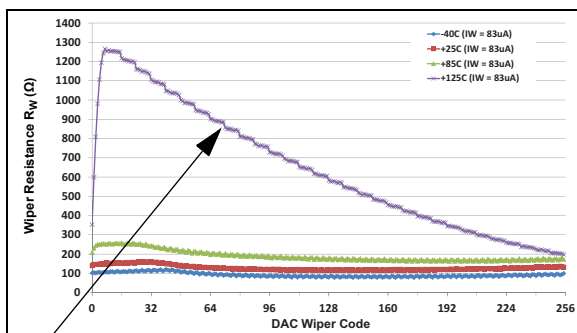

Measured R_W is influenced by the analog switch leakage at $+125^\circ\text{C}$. See Section 5.2.1 of the MCP41HVX1 data sheet (DS20005207A) for additional information.

FIGURE 1-212: Wiper Resistance (R_W) vs. Wiper Setting and Temperature
($100.0\text{ k}\Omega$, **8-bit**: $V_L = 1.8\text{V}, 2.7\text{V}, 5.5\text{V}$, $A = \text{V+}$, $B = \text{V-}$, $\text{DGND} = \text{V-}$, $\text{V+} = 10\text{V}$, $I_W = 83\text{ }\mu\text{A}$).

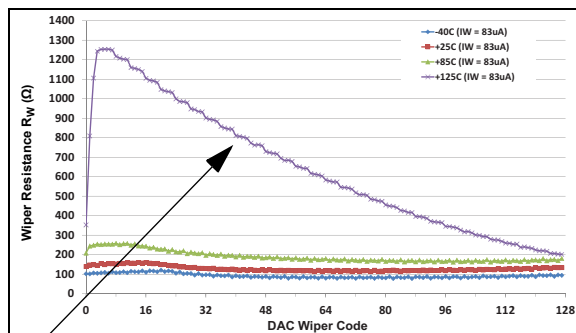

Measured R_W is influenced by the analog switch leakage at $+125^\circ\text{C}$. See Section 5.2.1 of the MCP41HVX1 data sheet (DS20005207A) for additional information.

FIGURE 1-215: Wiper Resistance (R_W) vs. Wiper Setting and Temperature
($100.0\text{ k}\Omega$, **7-bit**: $V_L = 1.8\text{V}, 2.7\text{V}, 5.5\text{V}$, $A = \text{V+}$, $B = \text{V-}$, $\text{DGND} = \text{V-}$, $\text{V+} = 10\text{V}$, $I_W = 83\text{ }\mu\text{A}$).

Note: Unless otherwise indicated, $T_A = +25^\circ\text{C}$, $V_L = 5.0\text{V}$, $\text{DGND} = V_-$, $V_+ = 36\text{V}$.

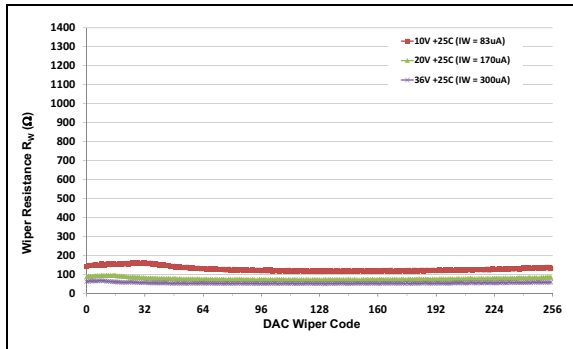

FIGURE 1-216: Wiper Resistance (R_W) vs. Wiper Setting @ 29°C
 ($100.0\text{ k}\Omega$, **8-bit**: $V_L = 1.8\text{V}, 2.7\text{V}, 5.5\text{V}$,
 $A = V_+$, $B = V_-$, $\text{DGND} = V_-$,
 $V_+ = 36\text{V}$ and $I_W = 300\text{ }\mu\text{A}$, $V_+ = 20\text{V}$ and
 $I_W = 170\text{ }\mu\text{A}$, $V_+ = 10\text{V}$ and $I_W = 83\text{ }\mu\text{A}$).

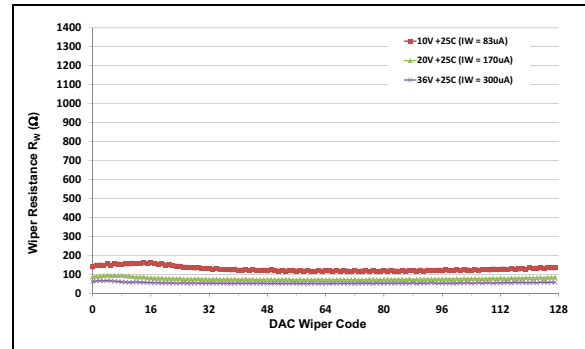

FIGURE 1-217: Wiper Resistance (R_W) vs. Wiper Setting @ 29°C
 ($100.0\text{ k}\Omega$, **7-bit**: $V_L = 1.8\text{V}, 2.7\text{V}, 5.5\text{V}$,
 $A = V_+$, $B = V_-$, $\text{DGND} = V_-$,
 $V_+ = 36\text{V}$ and $I_W = 300\text{ }\mu\text{A}$, $V_+ = 20\text{V}$ and
 $I_W = 170\text{ }\mu\text{A}$, $V_+ = 10\text{V}$ and $I_W = 83\text{ }\mu\text{A}$).

MCP41HVX1

Note: Unless otherwise indicated, $T_A = +25^\circ\text{C}$, $V_L = 5.0\text{V}$, $\text{DGND} = \text{V-}$, $\text{V+} = 36\text{V}$.

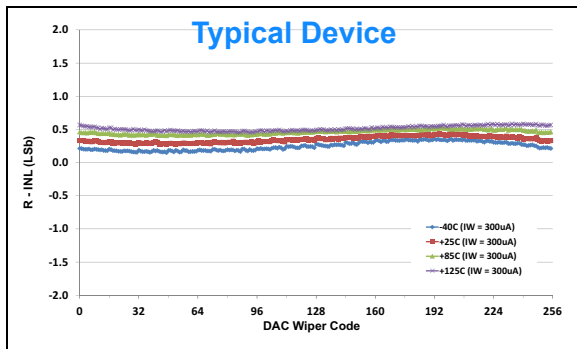

FIGURE 1-218: INL Error - Rheo. Mode (R-INL) vs. Wiper Setting and Temperature (100.0 kΩ, 8-bit: $V_L = 1.8\text{V}$, 2.7V, 5.5V, $A = \text{V+}$, $B = \text{V-}$, $\text{DGND} = \text{V-}$, $\text{V+} = 36\text{V}$, $I_W = 300\ \mu\text{A}$).

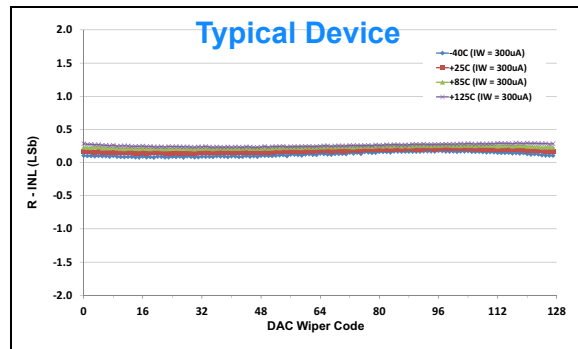

FIGURE 1-221: INL Error - Rheo. Mode (R-INL) vs. Wiper Setting and Temperature (100.0 kΩ, 7-bit: $V_L = 1.8\text{V}$, 2.7V, 5.5V, $A = \text{V+}$, $B = \text{V-}$, $\text{DGND} = \text{V-}$, $\text{V+} = 36\text{V}$, $I_W = 300\ \mu\text{A}$).

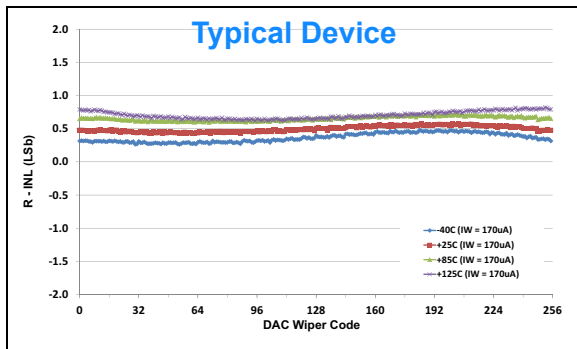

FIGURE 1-219: INL Error - Rheo. Mode (R-INL) vs. Wiper Setting and Temperature (100.0 kΩ, 8-bit: $V_L = 1.8\text{V}$, 2.7V, 5.5V, $A = \text{V+}$, $B = \text{V-}$, $\text{DGND} = \text{V-}$, $\text{V+} = 20\text{V}$, $I_W = 170\ \mu\text{A}$).

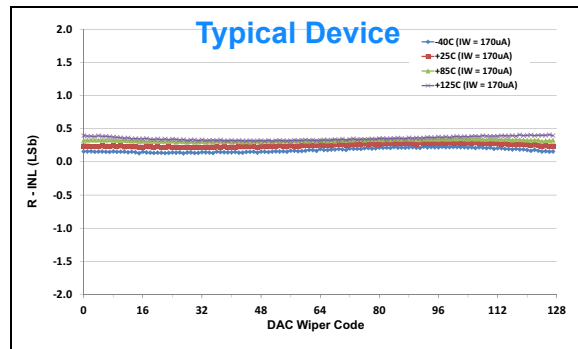

FIGURE 1-222: INL Error - Rheo. Mode (R-INL) vs. Wiper Setting and Temperature (100.0 kΩ, 7-bit: $V_L = 1.8\text{V}$, 2.7V, 5.5V, $A = \text{V+}$, $B = \text{V-}$, $\text{DGND} = \text{V-}$, $\text{V+} = 20\text{V}$, $I_W = 170\ \mu\text{A}$).

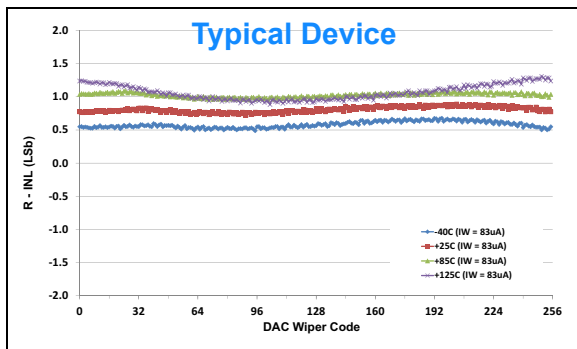

FIGURE 1-220: INL Error - Rheo. Mode (R-INL) vs. Wiper Setting and Temperature (100.0 kΩ, 8-bit: $V_L = 1.8\text{V}$, 2.7V, 5.5V, $A = \text{V+}$, $B = \text{V-}$, $\text{DGND} = \text{V-}$, $\text{V+} = 10\text{V}$, $I_W = 83\ \mu\text{A}$).

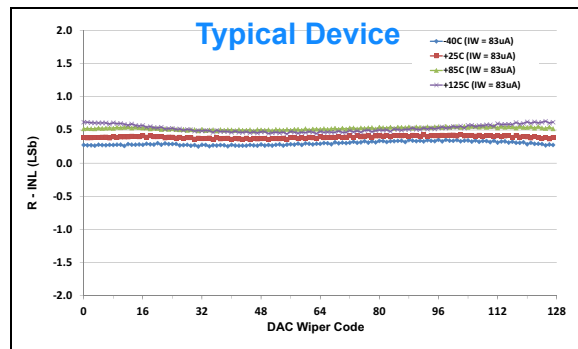

FIGURE 1-223: INL Error - Rheo. Mode (R-INL) vs. Wiper Setting and Temperature (100.0 kΩ, 7-bit: $V_L = 1.8\text{V}$, 2.7V, 5.5V, $A = \text{V+}$, $B = \text{V-}$, $\text{DGND} = \text{V-}$, $\text{V+} = 10\text{V}$, $I_W = 83\ \mu\text{A}$).

Note: Unless otherwise indicated, $T_A = +25^\circ\text{C}$, $V_L = 5.0\text{V}$, $\text{DGND} = V_-$, $V_+ = 36\text{V}$

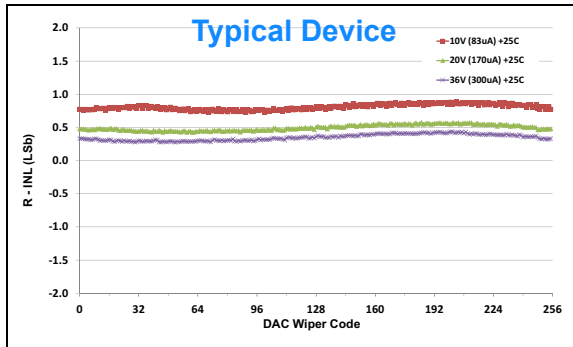

FIGURE 1-224: INL Error - Rheo. Mode (R-INL) vs. Wiper Setting (@ 25°C)
 ($100.0\text{ k}\Omega$, **8-bit**: $V_L = 1.8\text{V}, 2.7\text{V}, 5.5\text{V}$,
 $A = V_+$, $B = V_-$, $\text{DGND} = V_-$,
 $V_+ = 36\text{V}$ and $I_W = 300\text{ }\mu\text{A}$, $V_+ = 20\text{V}$ and
 $I_W = 170\text{ }\mu\text{A}$, $V_+ = 10\text{V}$ and $I_W = 83\text{ }\mu\text{A}$).

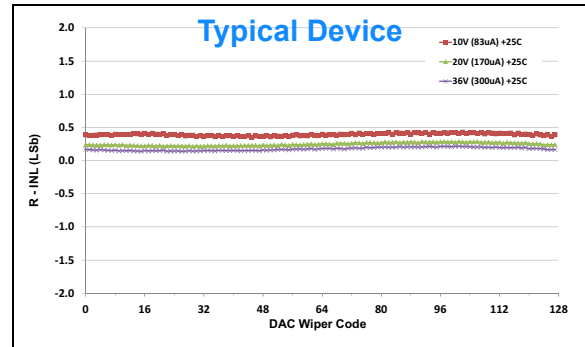

FIGURE 1-225: INL Error - Rheo. Mode (R-INL) vs. Wiper Setting (@ 25°C)
 ($100.0\text{ k}\Omega$, **7-bit**: $V_L = 1.8\text{V}, 2.7\text{V}, 5.5\text{V}$,
 $A = V_+$, $B = V_-$, $\text{DGND} = V_-$,
 $V_+ = 36\text{V}$ and $I_W = 300\text{ }\mu\text{A}$, $V_+ = 20\text{V}$ and
 $I_W = 170\text{ }\mu\text{A}$, $V_+ = 10\text{V}$ and $I_W = 83\text{ }\mu\text{A}$).

MCP41HVX1

Note: Unless otherwise indicated, $T_A = +25^\circ\text{C}$, $V_L = 5.0\text{V}$, $\text{DGND} = V^-$, $V^+ = 36\text{V}$.

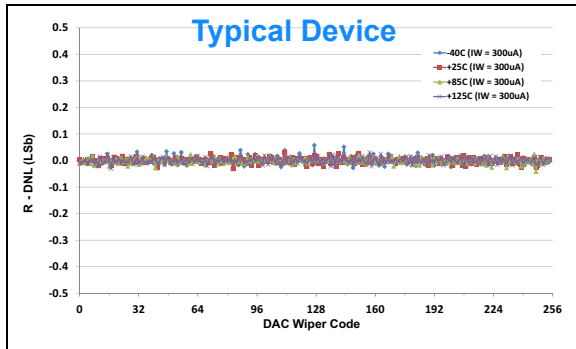

FIGURE 1-226: DNL Error - Rheo. Mode (R-DNL) vs. Wiper Setting and Temperature (100.0 kΩ, 8-bit: $V_L = 1.8\text{V}, 2.7\text{V}, 5.5\text{V}$, $A = V^+$, $B = V^-$, $\text{DGND} = V^-$, $V^+ = 36\text{V}$, $I_W = 300\ \mu\text{A}$).

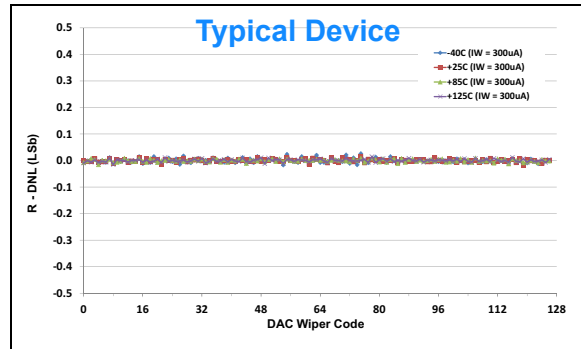

FIGURE 1-229: DNL Error - Rheo. Mode (R-DNL) vs. Wiper Setting and Temperature (100.0 kΩ, 7-bit: $V_L = 1.8\text{V}, 2.7\text{V}, 5.5\text{V}$, $A = V^+$, $B = V^-$, $\text{DGND} = V^-$, $V^+ = 36\text{V}$, $I_W = 300\ \mu\text{A}$).

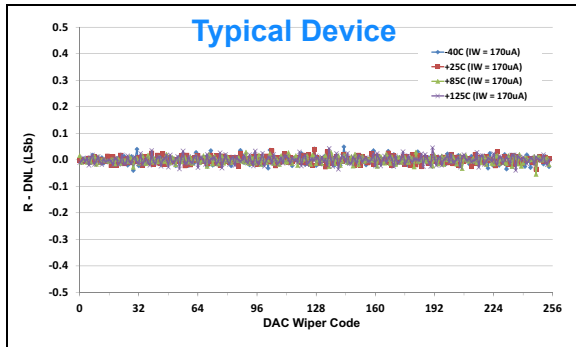

FIGURE 1-227: DNL Error - Rheo. Mode (R-DNL) vs. Wiper Setting and Temperature (100.0 kΩ, 8-bit: $V_L = 1.8\text{V}, 2.7\text{V}, 5.5\text{V}$, $A = V^+$, $B = V^-$, $\text{DGND} = V^-$, $V^+ = 20\text{V}$, $I_W = 170\ \mu\text{A}$).

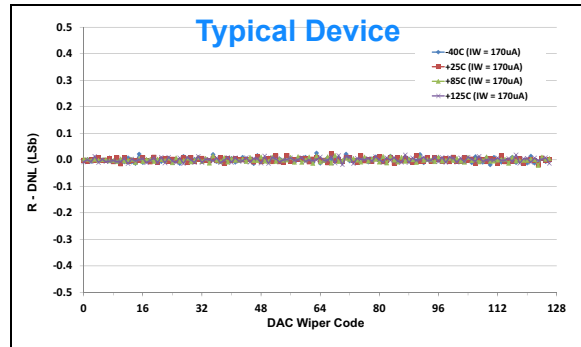

FIGURE 1-230: DNL Error - Rheo. Mode (R-DNL) vs. Wiper Setting and Temperature (100.0 kΩ, 7-bit: $V_L = 1.8\text{V}, 2.7\text{V}, 5.5\text{V}$, $A = V^+$, $B = V^-$, $\text{DGND} = V^-$, $V^+ = 20\text{V}$, $I_W = 170\ \mu\text{A}$).

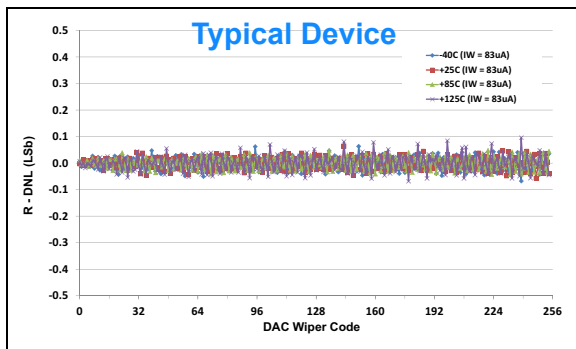

FIGURE 1-228: DNL Error - Rheo. Mode (R-DNL) vs. Wiper Setting and Temperature (100.0 kΩ, 8-bit: $V_L = 1.8\text{V}, 2.7\text{V}, 5.5\text{V}$, $A = V^+$, $B = V^-$, $\text{DGND} = V^-$, $V^+ = 10\text{V}$, $I_W = 83\ \mu\text{A}$).

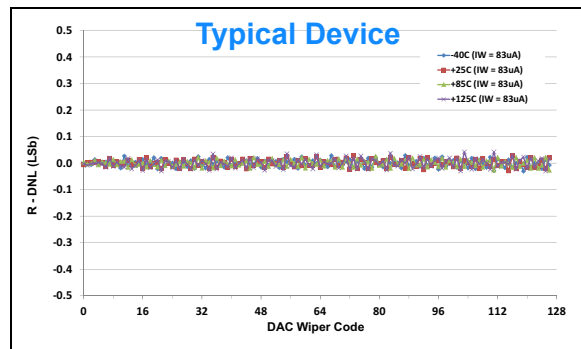

FIGURE 1-231: DNL Error - Rheo. Mode (R-DNL) vs. Wiper Setting and Temperature (100.0 kΩ, 7-bit: $V_L = 1.8\text{V}, 2.7\text{V}, 5.5\text{V}$, $A = V^+$, $B = V^-$, $\text{DGND} = V^-$, $V^+ = 10\text{V}$, $I_W = 83\ \mu\text{A}$).

Note: Unless otherwise indicated, $T_A = +25^\circ\text{C}$, $V_L = 5.0\text{V}$, $\text{DGND} = V_-$, $V_+ = 36\text{V}$.

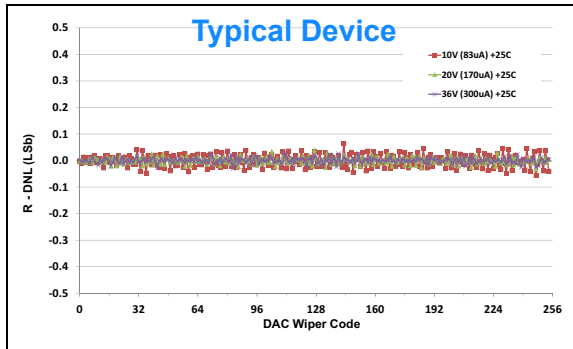

FIGURE 1-232: DNL Error - Rheo. Mode (R-DNL) vs. Wiper Setting (@ 25°C) ($100.0\text{ k}\Omega$, **8-bit**: $V_L = 1.8\text{V}$, 2.7V , 5.5V , $A = V_+$, $B = V_-$, $\text{DGND} = V_-$, $V_+ = 36\text{V}$ and $I_W = 300\text{ }\mu\text{A}$, $V_+ = 20\text{V}$ and $I_W = 170\text{ }\mu\text{A}$, $V_+ = 10\text{V}$ and $I_W = 83\text{ }\mu\text{A}$).

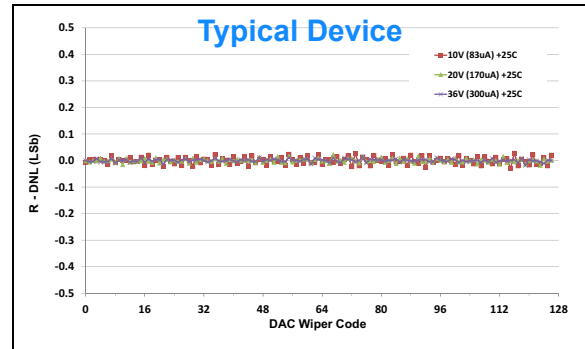

FIGURE 1-233: DNL Error - Rheo. Mode (R-DNL) vs. Wiper Setting (@ 25°C) ($100.0\text{ k}\Omega$, **7-bit**: $V_L = 1.8\text{V}$, 2.7V , 5.5V , $A = V_+$, $B = V_-$, $\text{DGND} = V_-$, $V_+ = 36\text{V}$ and $I_W = 300\text{ }\mu\text{A}$, $V_+ = 20\text{V}$ and $I_W = 170\text{ }\mu\text{A}$, $V_+ = 10\text{V}$ and $I_W = 83\text{ }\mu\text{A}$).

MCP41HVX1

Note: Unless otherwise indicated, $T_A = +25^\circ\text{C}$, $V_L = 5.0\text{V}$, $\text{DGND} = \text{V-}$, $\text{V+} = 36\text{V}$.

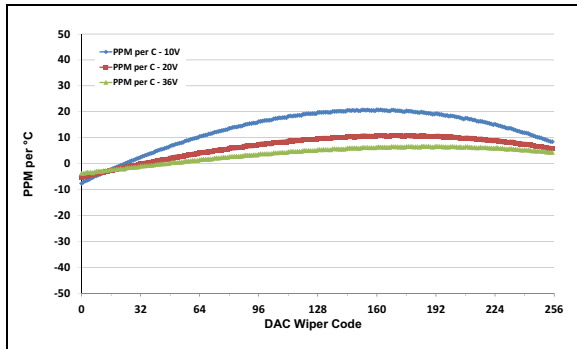

FIGURE 1-234: $V_W \text{ PPM}/^\circ\text{C}$ (Pot. Mode) vs. Temperature, and $V+$ Voltage

$$\left(\left(V_{W(\text{code}=n, 125^\circ\text{C})} - V_{W(\text{code}=n, -40^\circ\text{C})} \right) / V_{W(\text{code}=255, 25^\circ\text{C})} \right) * 1,000,000 / 165^\circ\text{C}$$

(100.0 kΩ, 8-bit: $V_L = 1.8\text{V}, 2.7\text{V}, 5.5\text{V}$, $A = \text{V+}, B = \text{V-}, \text{DGND} = \text{V-}, \text{V+} = 36\text{V}, 20\text{V}, 10\text{V}$).

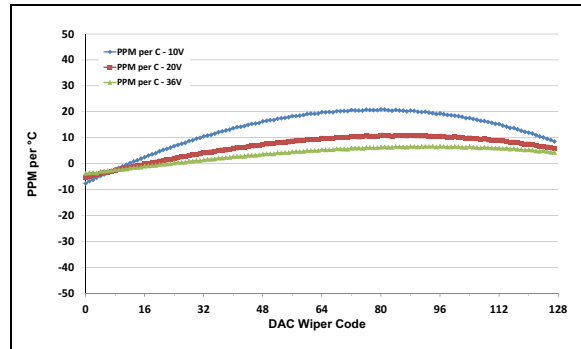

FIGURE 1-235: $V_W \text{ PPM}/^\circ\text{C}$ (Pot. Mode) vs. Temperature, and $V+$ Voltage

$$\left(\left(V_{W(\text{code}=n, 125^\circ\text{C})} - V_{W(\text{code}=n, -40^\circ\text{C})} \right) / V_{W(\text{code}=127, 25^\circ\text{C})} \right) * 1,000,000 / 165^\circ\text{C}$$

(100.0 kΩ, 7-bit: $V_L = 1.8\text{V}, 2.7\text{V}, 5.5\text{V}$, $A = \text{V+}, B = \text{V-}, \text{DGND} = \text{V-}, \text{V+} = 36\text{V}, 20\text{V}, 10\text{V}$).

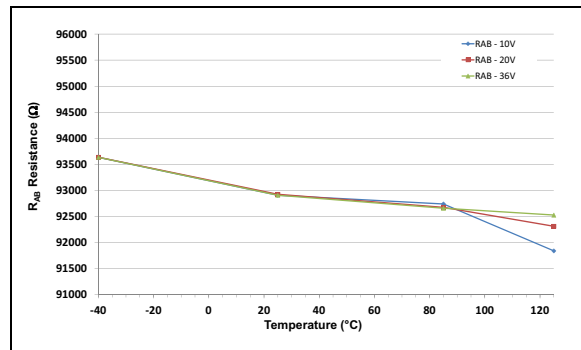

FIGURE 1-236: R_{AB} Resistance vs. Temperature and $V+$ Voltage
(100.0 kΩ: $V_L = 1.8\text{V}, 2.7\text{V}, 5.5\text{V}$, $A = \text{V+}, B = \text{V-}, \text{DGND} = \text{V-}, \text{V+} = 36\text{V}, 20\text{V}, 10\text{V}$).

1.1 Test Circuits

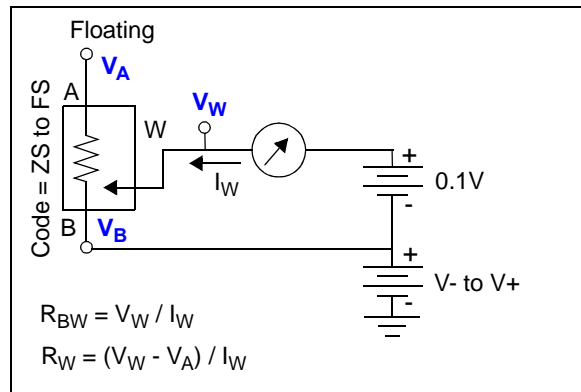

FIGURE 1-237: R_W and R_{BW} Measurement.

APPENDIX A: REVISION HISTORY

Revision A (June 2013)

- Original Release of this Document.

MCP41HVX1

NOTES:

Note the following details of the code protection feature on Microchip devices:

- Microchip products meet the specification contained in their particular Microchip Data Sheet.
- Microchip believes that its family of products is one of the most secure families of its kind on the market today, when used in the intended manner and under normal conditions.
- There are dishonest and possibly illegal methods used to breach the code protection feature. All of these methods, to our knowledge, require using the Microchip products in a manner outside the operating specifications contained in Microchip's Data Sheets. Most likely, the person doing so is engaged in theft of intellectual property.
- Microchip is willing to work with the customer who is concerned about the integrity of their code.
- Neither Microchip nor any other semiconductor manufacturer can guarantee the security of their code. Code protection does not mean that we are guaranteeing the product as “unbreakable.”

Code protection is constantly evolving. We at Microchip are committed to continuously improving the code protection features of our products. Attempts to break Microchip's code protection feature may be a violation of the Digital Millennium Copyright Act. If such acts allow unauthorized access to your software or other copyrighted work, you may have a right to sue for relief under that Act.

Information contained in this publication regarding device applications and the like is provided only for your convenience and may be superseded by updates. It is your responsibility to ensure that your application meets with your specifications. MICROCHIP MAKES NO REPRESENTATIONS OR WARRANTIES OF ANY KIND WHETHER EXPRESS OR IMPLIED, WRITTEN OR ORAL, STATUTORY OR OTHERWISE, RELATED TO THE INFORMATION, INCLUDING BUT NOT LIMITED TO ITS CONDITION, QUALITY, PERFORMANCE, MERCHANTABILITY OR FITNESS FOR PURPOSE. Microchip disclaims all liability arising from this information and its use. Use of Microchip devices in life support and/or safety applications is entirely at the buyer's risk, and the buyer agrees to defend, indemnify and hold harmless Microchip from any and all damages, claims, suits, or expenses resulting from such use. No licenses are conveyed, implicitly or otherwise, under any Microchip intellectual property rights.

Trademarks

The Microchip name and logo, the Microchip logo, dsPIC, FlashFlex, KEELOQ, KEELOQ logo, MPLAB, PIC, PICmicro, PICSTART, PIC³² logo, rPIC, SST, SST Logo, SuperFlash and UNI/O are registered trademarks of Microchip Technology Incorporated in the U.S.A. and other countries.

FilterLab, Hampshire, HI-TECH C, Linear Active Thermistor, MTP, SEEVAL and The Embedded Control Solutions Company are registered trademarks of Microchip Technology Incorporated in the U.S.A.

Silicon Storage Technology is a registered trademark of Microchip Technology Inc. in other countries.

Analog-for-the-Digital Age, Application Maestro, BodyCom, chipKIT, chipKIT logo, CodeGuard, dsPICDEM, dsPICDEM.net, dsPICworks, dsSPEAK, ECAN, ECONOMONITOR, FanSense, HI-TIDE, In-Circuit Serial Programming, ICSP, Mindi, MiWi, MPASM, MPF, MPLAB Certified logo, MPLIB, MPLINK, mTouch, Omniclient Code Generation, PICC, PICC-18, PICDEM, PICDEM.net, PICkit, PICtail, REAL ICE, rLAB, Select Mode, SQI, Serial Quad I/O, Total Endurance, TSHARC, UniWinDriver, WiperLock, ZENA and Z-Scale are trademarks of Microchip Technology Incorporated in the U.S.A. and other countries.

SQTP is a service mark of Microchip Technology Incorporated in the U.S.A.

GestIC and ULPP are registered trademarks of Microchip Technology Germany II GmbH & Co. KG, a subsidiary of Microchip Technology Inc., in other countries.

All other trademarks mentioned herein are property of their respective companies.

© 2013, Microchip Technology Incorporated, Printed in the U.S.A., All Rights Reserved.

 Printed on recycled paper.

ISBN: 978-1-62077-255-3

QUALITY MANAGEMENT SYSTEM
CERTIFIED BY DNV
== ISO/TS 16949 ==

Microchip received ISO/TS-16949:2009 certification for its worldwide headquarters, design and wafer fabrication facilities in Chandler and Tempe, Arizona; Gresham, Oregon and design centers in California and India. The Company's quality system processes and procedures are for its PIC[®] MCUs and dsPIC[®] DSCs, KEELOQ[®] code hopping devices, Serial EEPROMs, microperipherals, nonvolatile memory and analog products. In addition, Microchip's quality system for the design and manufacture of development systems is ISO 9001:2000 certified.



MICROCHIP

Worldwide Sales and Service

AMERICAS

Corporate Office
2355 West Chandler Blvd.
Chandler, AZ 85224-6199
Tel: 480-792-7200
Fax: 480-792-7277
Technical Support:
<http://www.microchip.com/support>
Web Address:
www.microchip.com

Atlanta
Duluth, GA
Tel: 678-957-9614
Fax: 678-957-1455

Boston
Westborough, MA
Tel: 774-760-0087
Fax: 774-760-0088

Chicago
Itasca, IL
Tel: 630-285-0071
Fax: 630-285-0075

Cleveland
Independence, OH
Tel: 216-447-0464
Fax: 216-447-0643

Dallas
Addison, TX
Tel: 972-818-7423
Fax: 972-818-2924

Detroit
Farmington Hills, MI
Tel: 248-538-2250
Fax: 248-538-2260

Indianapolis
Noblesville, IN
Tel: 317-773-8323
Fax: 317-773-5453

Los Angeles
Mission Viejo, CA
Tel: 949-462-9523
Fax: 949-462-9608

Santa Clara
Santa Clara, CA
Tel: 408-961-6444
Fax: 408-961-6445

Toronto
Mississauga, Ontario,
Canada
Tel: 905-673-0699
Fax: 905-673-6509

ASIA/PACIFIC

Asia Pacific Office
Suites 3707-14, 37th Floor
Tower 6, The Gateway
Harbour City, Kowloon
Hong Kong
Tel: 852-2401-1200
Fax: 852-2401-3431

Australia - Sydney
Tel: 61-2-9868-6733
Fax: 61-2-9868-6755

China - Beijing
Tel: 86-10-8569-7000
Fax: 86-10-8528-2104

China - Chengdu
Tel: 86-28-8665-5511
Fax: 86-28-8665-7889

China - Chongqing
Tel: 86-23-8980-9588
Fax: 86-23-8980-9500

China - Hangzhou
Tel: 86-571-2819-3187
Fax: 86-571-2819-3189

China - Hong Kong SAR
Tel: 852-2943-5100
Fax: 852-2401-3431

China - Nanjing
Tel: 86-25-8473-2460
Fax: 86-25-8473-2470

China - Qingdao
Tel: 86-532-8502-7355
Fax: 86-532-8502-7205

China - Shanghai
Tel: 86-21-5407-5533
Fax: 86-21-5407-5066

China - Shenyang
Tel: 86-24-2334-2829
Fax: 86-24-2334-2393

China - Shenzhen
Tel: 86-755-8864-2200
Fax: 86-755-8203-1760

China - Wuhan
Tel: 86-27-5980-5300
Fax: 86-27-5980-5118

China - Xian
Tel: 86-29-8833-7252
Fax: 86-29-8833-7256

China - Xiamen
Tel: 86-592-2388138
Fax: 86-592-2388130

China - Zhuhai
Tel: 86-756-3210040
Fax: 86-756-3210049

ASIA/PACIFIC

India - Bangalore
Tel: 91-80-3090-4444
Fax: 91-80-3090-4123

India - New Delhi
Tel: 91-11-4160-8631
Fax: 91-11-4160-8632

India - Pune
Tel: 91-20-2566-1512
Fax: 91-20-2566-1513

Japan - Osaka
Tel: 81-6-6152-7160
Fax: 81-6-6152-9310

Japan - Tokyo
Tel: 81-3-6880-3770
Fax: 81-3-6880-3771

Korea - Daegu
Tel: 82-53-744-4301
Fax: 82-53-744-4302

Korea - Seoul
Tel: 82-2-554-7200
Fax: 82-2-558-5932 or
82-2-558-5934

Malaysia - Kuala Lumpur
Tel: 60-3-6201-9857
Fax: 60-3-6201-9859

Malaysia - Penang
Tel: 60-4-227-8870
Fax: 60-4-227-4068

Philippines - Manila
Tel: 63-2-634-9065
Fax: 63-2-634-9069

Singapore
Tel: 65-6334-8870
Fax: 65-6334-8850

Taiwan - Hsin Chu
Tel: 886-3-5778-366
Fax: 886-3-5770-955

Taiwan - Kaohsiung
Tel: 886-7-213-7828
Fax: 886-7-330-9305

Taiwan - Taipei
Tel: 886-2-2508-8600
Fax: 886-2-2508-0102

Thailand - Bangkok
Tel: 66-2-694-1351
Fax: 66-2-694-1350

EUROPE

Austria - Wels
Tel: 43-7242-2244-39
Fax: 43-7242-2244-393

Denmark - Copenhagen
Tel: 45-4450-2828
Fax: 45-4485-2829

France - Paris
Tel: 33-1-69-53-63-20
Fax: 33-1-69-30-90-79

Germany - Munich
Tel: 49-89-627-144-0
Fax: 49-89-627-144-44

Italy - Milan
Tel: 39-0331-742611
Fax: 39-0331-466781

Netherlands - Drunen
Tel: 31-416-690399
Fax: 31-416-690340

Spain - Madrid
Tel: 34-91-708-08-90
Fax: 34-91-708-08-91

UK - Wokingham
Tel: 44-118-921-5869
Fax: 44-118-921-5820

11/29/12